

Customer
 Date 30.09.2024
 Project
 Reference
 Quotation No



Stefani S.p.A.
 Via del Lavoro, 9
 Castegnero (VI) - ITALY
 Tel. +39 0444 639 999
 Fax. +39 0444 638 240

Condenser
 Model 1 x SCIROCCO H 35-2 B 4 S H

Capacity	19,5 kW	Refrigerant	R452a
Air Inlet Temperature	25,0 °C	Condensing Temp	Dew 40,0 °C
Relative Humidity In	50 %	Gas Inlet Temperature	75 °C
Altitude	0 m		
Air Flow	5000 m³/h	RPM rate	100 %
Number fans	2	Fan Speed	1340 1/min
Fan Diameter	350 mm	Noise Power Level	72 dB(A)
Voltage	230 V	Noise Pressure Level ISO 3744	41 dB(A) at 10 m
Frequency	50 Hz	Power consumption	330 W
Power Supply	Single Phase	Nominal Power	330 W
Available Static Pressure	0 Pa	Nominal Current (*)	1,46 A

Surface	30,0 m²	Tubes	Copper
Internal Volume	3,0 dm³	Fins	Aluminium
Fin Spacing	2,4 mm	Casing	Galvanized Steel Painted
Weight	37 kg	Length	1373 mm
Connections IN	22 mm	Height	536 mm
Connections OUT	18 mm	Width	445 mm
Connections position	Same side	PS	45 bar

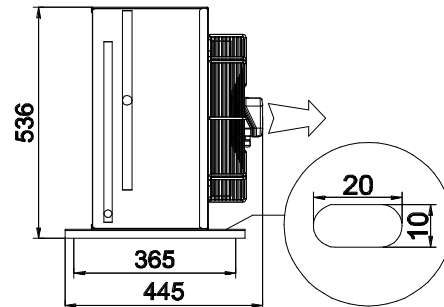
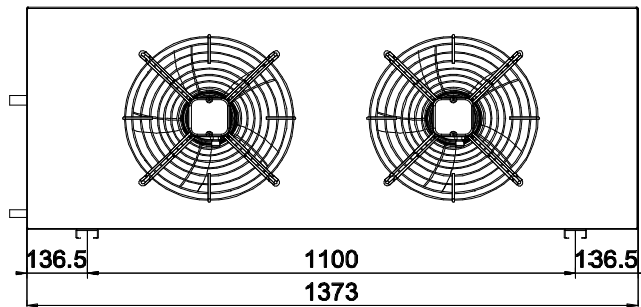

(*)ERP COMPLIANT Current consumption can be different due to the air temperature

NOTE

Customer
Phone
Fax
e-mail
Date 30.09.2024
Project
Reference
Quotation No



Stefani S.p.A.
Via del Lavoro, 9
Castegnero (VI) - ITALY
Tel. +39 0444 639 999
Fax. +39 0444 638 240

Condenser

Model 1 x SCIROCCO H 35-2 B 4 S H

TECHNICAL AND CONTRACTUAL NOTES

APPROVAL: At order, the countersigned approval of Stefani Sales conditions and executive drawing is required

CORROSION: Corrosion resistance warranty is excluded unless otherwise specified and agreed. The compatibility of materials with the characteristics of the environment in which the unit is installed is the responsibility of the customer.

WEIGHT AND DIMENSIONS: The commercial sheet does not indicate the shipping dimensions and weights. The data declared are to be considered indicative and are not valid for all possible configurations of accessories. See drawing for approval.

CONNECTION SIDE: Conventionally for all of the unit with horizontal air flow, the connection side is defined as right D, standard Stefani, when compared to the same direction of the air the connection is on the right, otherwise it will be called left S. The standard connection of the units with blowing fans on the finned pack is on the left S.

MOTORS WARRANTY: The built-in thermal protection of the motors must be connected to the safety devices and ensure the interruption of the power supply in case of switching.

RISK OF FREEZING: The standard units operating with liquid cannot be completely self-draining, the choice of the concentration of the antifreeze fluid must be made according to the minimum temperature that can be reached in the place of installation and is the responsibility of the customer.

ACOUSTIC DATA: The sound power data of heat exchanger are derived from those declared by the fan manufacturer. Stefani Spa considers + 3dB (A) as a worse element due to the unit-fan combination. However, under certain conditions of installation or use, this value can vary significantly. In the datasheet, in accordance with EN13487, the sound pressure level is calculated in free field on a plane reflecting surface (source factor equal to 2) starting from the data mentioned above.

INSTALLATION: Stefani products are suitable for industrial B2B applications: installation in exclusively residential areas is not allowed unless otherwise specified and agreed upon at order

COMMISSIONING: Stefani products must be installed and started up by qualified technicians that must ensure the correct operation of the equipment in the system and must promptly report any anomalies to Stefani S.p.A.

CE COMPLIANCE: The units are equipped with fans that meet the efficiency requirements of the ERP 2009-125-EC directive and are labeled according to the CE marking valid for the European Union.