

Date of last update: Mar-15

Ref: D7.21.2/0612-0315/E

Application Engineering Europe

STREAM SEMI-HERMETIC COMPRESSOR CAPACITY CONTROL

1 Compressor capacity modulation for air-conditioning & refrigeration systems

1.1 Capacity control

Compressors in the higher capacity range need some form of capacity control to accommodate varying refrigeration load. The capacity control kit supplied by Emerson Climate Technologies will reduce the refrigeration capacity along with a similar proportional reduction in power input. This ensures optimum performance even in part load.

Capacity control is also required when the condensing pressure falls with a drop in ambient air temperature. The compressor suction condition, refrigerant volume and mass flow rate will remain unchanged. The capacity will increase due to the increase in Δh , along with the increase in volumetric efficiency (see the Ph chart below).

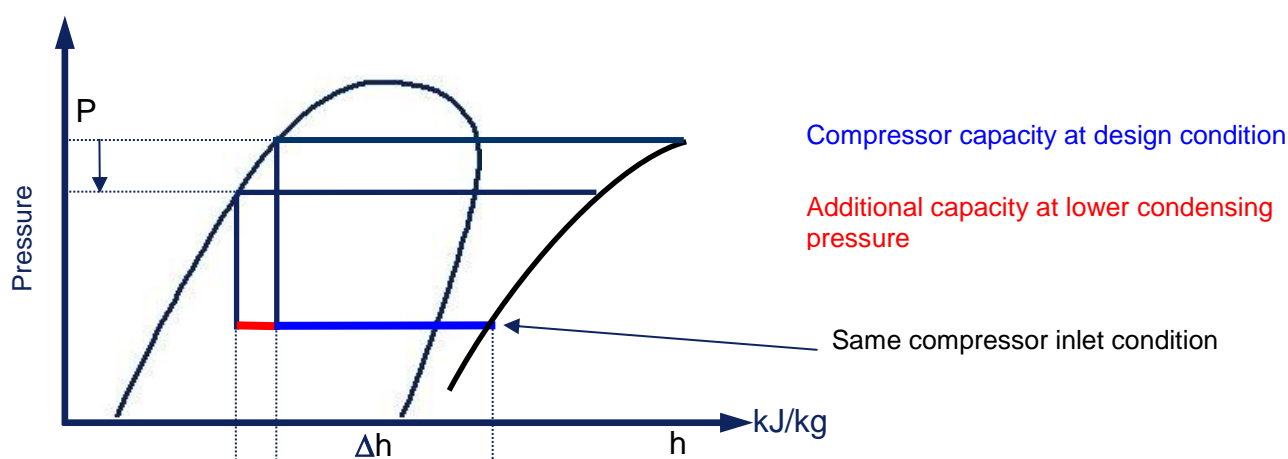

Figure 1: Ph chart

1.2 Methods of capacity control

There are many methods of capacity control for semi-hermetic compressors but Emerson Climate Technologies uses the "Blocked Suction method".

NOTE: Oil circulation in systems with capacity control is more critical.

Advantages:

- Reduces the starting frequency of the compressors;
- Ensure satisfactory operation with optimal capacity data;
- Energy cost saving even at partial load.

Disadvantages:

- Motor is less cooled (refrigerant flow reduced);
- Restriction of the application range;
- Oil circulation is more critical.

2 Copeland Stream models capacity control

All Stream compressor models can be equipped with a mechanical capacity control.

Be aware that capacity-controlled operation changes the application range of the compressor.

2.1 Capacity control

Capacity-controlled 4M* and 6M* compressors work on the principle of blocking the suction gas passage to two or more cylinders. They require the use of a special cylinder head, a control valve with solenoid coil, and a special valve plate, too. These items may be ordered factory- installed or in kit form for later installation.

2.1.1 Inactive capacity control

To prevent transport damage the solenoid valves are supplied loose with the compressor and the cylinder head is fitted with a shipping plate.

All capacity-control prepared cylinder heads on 4- and 6-cylinder Stream compressors are delivered with the mounted active gasket for the capacity controlled port. This will ensure full capacity operation of the compressor if the solenoid control valve is not installed for any reason.

To activate the capacity control, the blind flange has to be removed and replaced by the solenoid control valve from the control valve kit.

The control valve kit includes the solenoid valve with coil, gasket and connection pack up.

2.1.2 Retrofit kit (conversion kit)

A conversion kit for subsequent installation can also be delivered.

The kit includes:

- 1 x cylinder head for capacity control
- 1 x valve plate and gasket kit
- 1 x solenoid valve assembly
- 2 x mounting screws

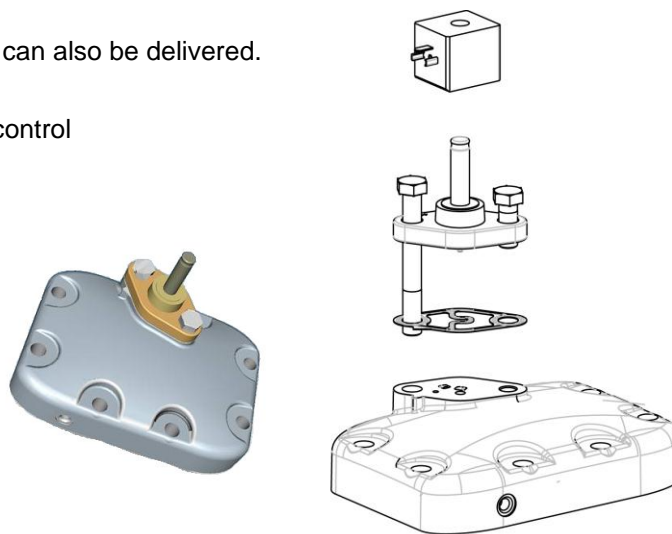

Figure 2: assembly of the capacity control kit

2.1.3 Normal operation full load

When the solenoid coil is not energized the top of the control piston is vented to suction pressure allowing the piston to be lifted by means of a spring. The compressor draws gas from all cylinders and reaches full cooling capacity.

2.1.4 Capacity-controlled operation (Part load)

When the solenoid coil is energized the top of the control piston is forced down by gas at discharge pressure blocking the suction gas passage into the cylinders thus enabling the compressor to run with a reduced capacity.

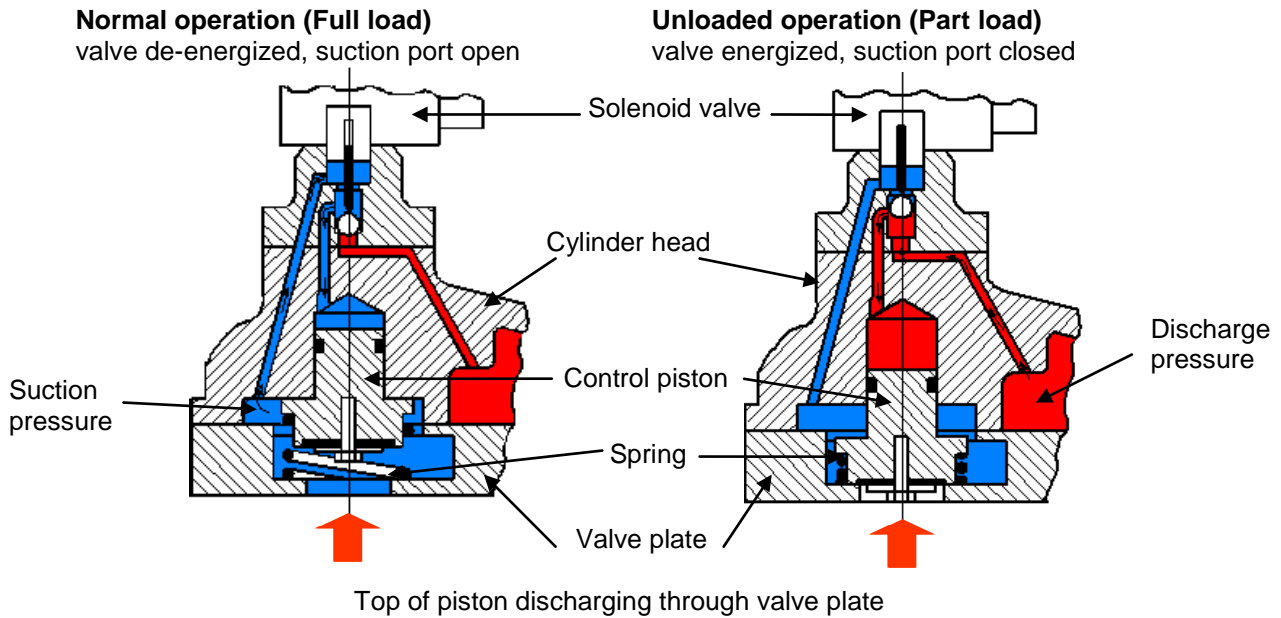

Figure 3: Capacity-controlled operation

NOTE: The capacity control should not cycle more than 10 times per hour.

Voltages of the solenoid valve coil:

- 24V DC
- 24V / 1 Ph / 50 Hz
- 120V / 1 Ph / 50 / 60 Hz
- 208-240V / 1 Ph / 50 / 60 Hz

Protection class: IP 55 (evaluation according to IEC 34).

2.2 Capacity control position

Capacity control must be fitted in the following positions:

4M*	50%	Terminal box side
6M* 1 st step	33%	Upper cylinder head
6M* 2 nd step	66%	Terminal box side

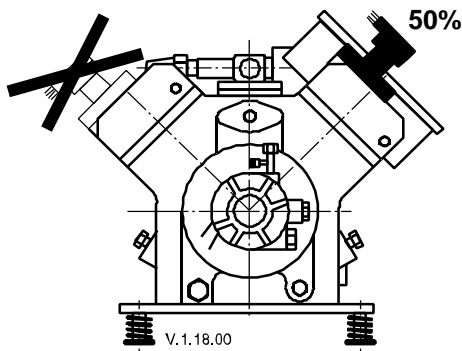
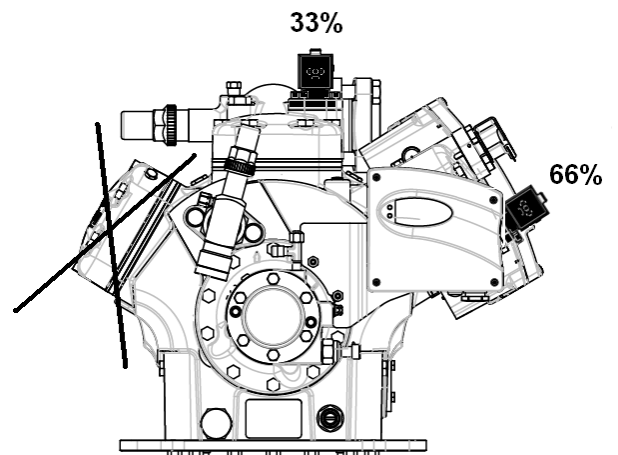

Figure 4: Capacity control position 4M*



Capacity control position 6M*

2.3 Capacity control with R404A

2.3.1 Capacity control selection

Compressor	Number of cylinders with capacity control	Capacity regulation step			Remaining refrigeration capacity % (average values)		Remaining power input % (average values)		Figure nr
		0	1	2	Application range				
					HM	ML	HM	ML	
4MA-22X	2	100%	50%		52		56		5
4MH-25X	2	100%	50%		52		56		5
4MI-30X	2	100%	50%		52		56		5
4MJ-30X	2	100%	50%		52		56		5
4MK-32X	2	100%	50%		52		56		5
4MF-13X	2	100%	50%			52		55	6
4ML-15X	2	100%	50%			52		55	6
4MM-20X	2	100%	50%			52		55	6
4MT-22X	2	100%	50%			52		55	6
4MU-25X	2	100%	50%			52		55	7
6MI-40X	2/4	100%	66%	33%	68/34		70/41		8/9
6MJ-45X	2/4	100%	66%	33%	68/34		70/41		8/9
6MK-50X	2/4	100%	66%	33%	68/34		70/41		8/9
6MM-30X	2/4	100%	66%	33%		69/36		69/39	10/11
6MT-35X	2/4	100%	66%	33%		69/36		69/39	10/11
6MU-40X	2/4	100%	66%	33%		69/36		69/39	10/11

Table 1: R404A Capacity control selection table

HM = High and medium temperature

ML = Medium and low temperature

2.3.2 R404A Application range

4MA-22X, 4MH-25X, 4MI-30X,
4MJ-33X, 4MK-35X

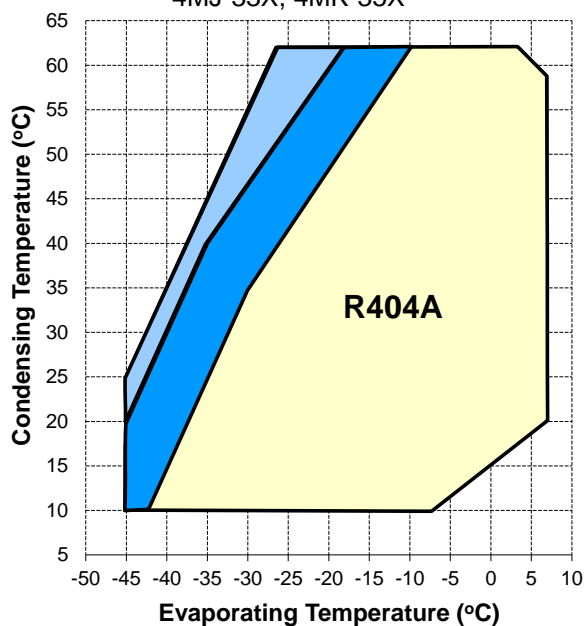

- 20°C Suction gas return
- 0°C Suction gas return
- 0°C Suction gas return + Additional fan

Figure 5: Medium and high temp 4M* @ 50% - R404A (1 capacity control)

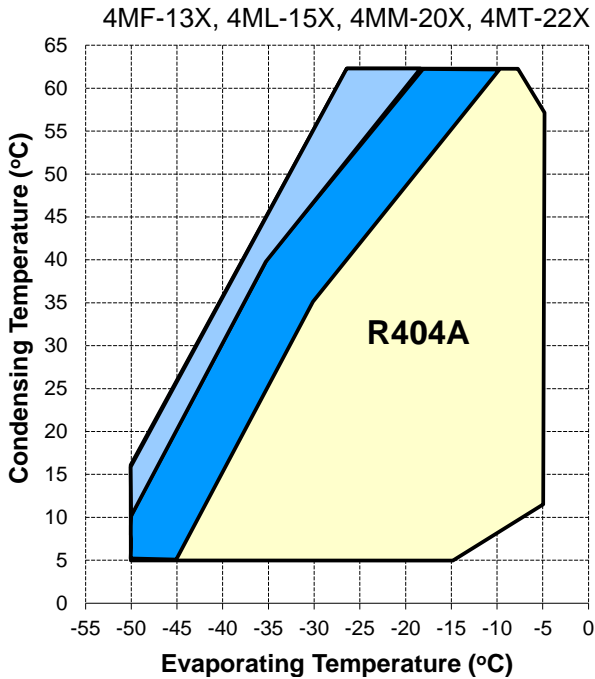

Figure 6: Low and medium temp 4M* @ 50% - R404A (1 capacity control)

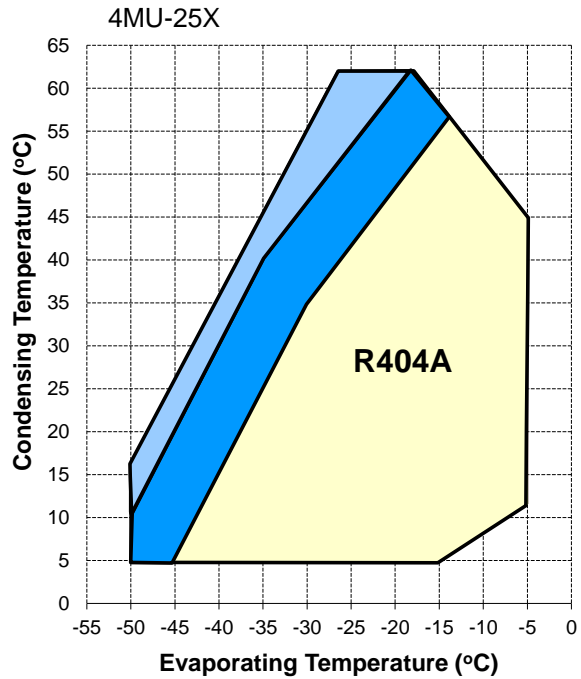

Figure 7: Low and medium temp 4M* @ 50% - R404A (1 capacity control)

- 20°C Suction gas return
- 0°C Suction gas return
- 0°C Suction gas return + Additional fan

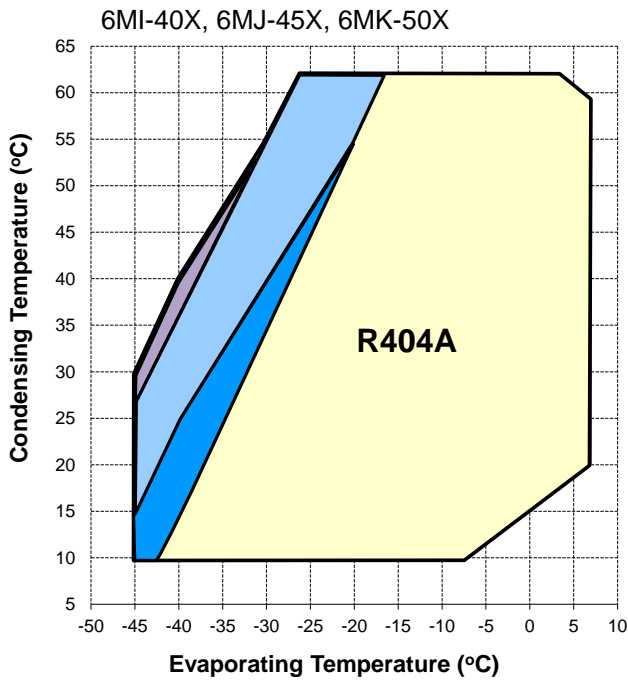

Figure 8: Medium and high temp 6M* @ 66% - R404A (1 capacity control)

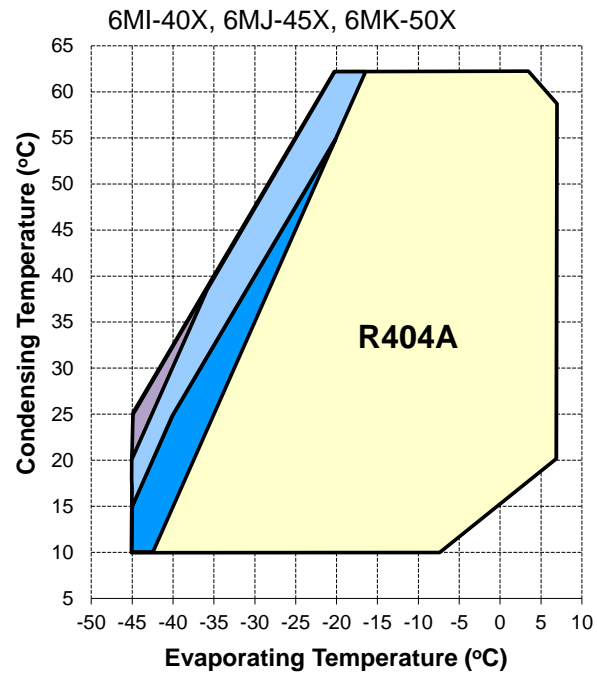

Figure 9: Medium and high temp 6M* @ 33% - R404A (2 capacity controls)

- 20°C Suction gas return
- 20°C Suction gas return + Additional fan
- 0°C Suction gas return
- 0°C Suction gas return + Additional fan

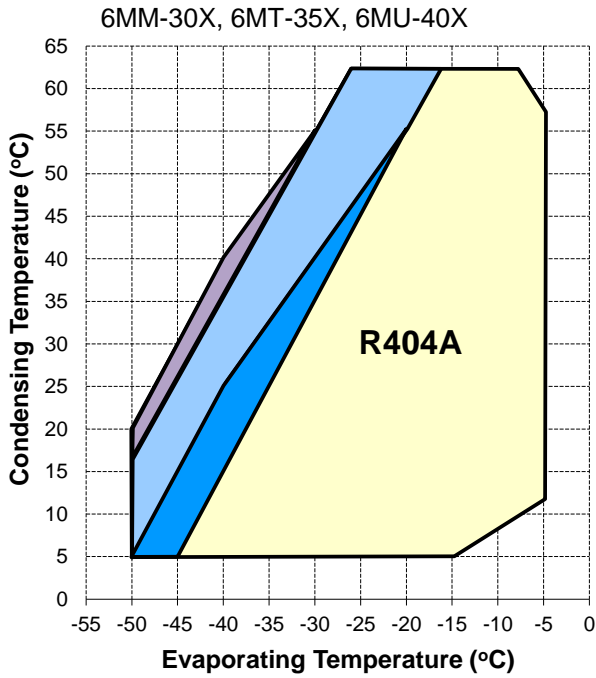

Figure 10: Low and medium temp 6M* @ 66% - R404A
(1 capacity control)

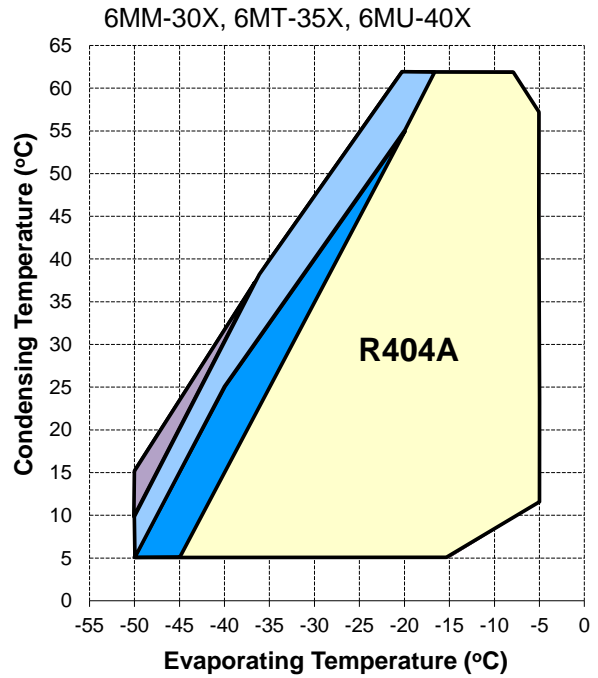





Figure 11: Low and medium temp 6M* @ 33% - R404A
(2 capacity controls)

-  20°C Suction gas return
-  20°C Suction gas return + Additional fan
-  0°C Suction gas return
-  0°C Suction gas return + Additional fan

2.4 Capacity control with R134a

2.4.1 Capacity control selection

Compressor	Number of cylinders with capacity control	Capacity regulation step			Remaining refrigeration capacity % (average values)		Remaining power input % (average values)		Figure nr
		0	1	2	Application range				
					HH	HM	HH	HM	
4MA-22X	2	100%	50%		50		56		12
4MH-25X	2	100%	50%		50		56		13
4MI-30X	2	100%	50%		50		56		14
4MJ-30X	2	100%	50%		50		56		14
4MK-32X	2	100%	50%		50		56		14
4MF-13X	2	100%	50%			50		54	15
4ML-15X	2	100%	50%			50		54	15
4MM-20X	2	100%	50%			50		54	15
4MT-22X	2	100%	50%			50		54	15
4MU-25X	2	100%	50%			50		54	15
6MI-40X	2/4	100%	66%	33%	68/34		71/40		16/17
6MJ-45X	2/4	100%	66%	33%	68/34		71/40		16/17
6MK-50X	2/4	100%	66%	33%	68/34		71/40		16/17
6MM-30X	2/4	100%	66%	33%		68/34		70/39	18/19
6MT-35X	2/4	100%	66%	33%		68/34		70/39	18/19
6MU-40X	2/4	100%	66%	33%		68/34		70/39	18/19

Table 2: R134a Capacity control selection table

HH = High temperature

HM = High and medium temperature

2.4.2 R134a Application range

4MA-22X

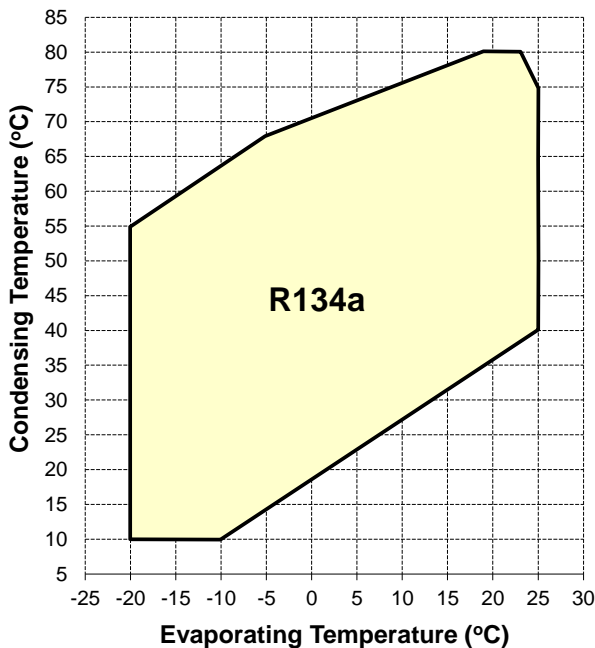

Figure 12: High temp 4M* @ 50% - R134a (1 capacity control)

4MH-25X

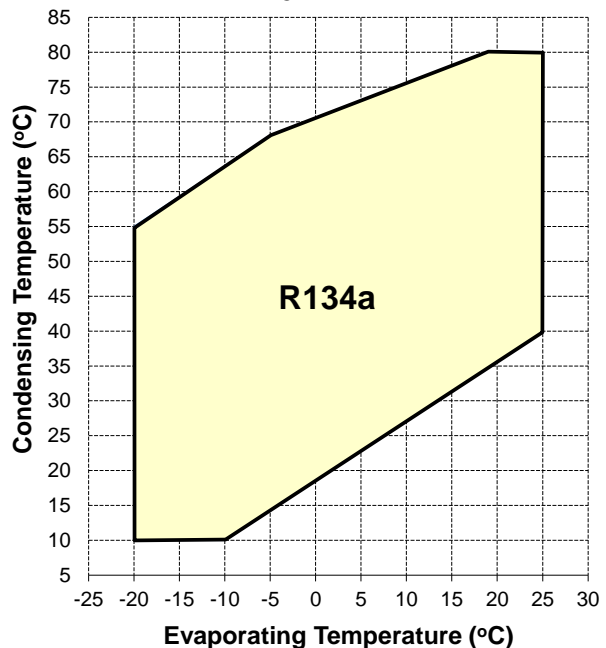

Figure 13: High temp 4M* @ 50% - R134a (1 capacity control)

20K Superheat

4MI-30X, 4MJ-33X, 4MK-35X

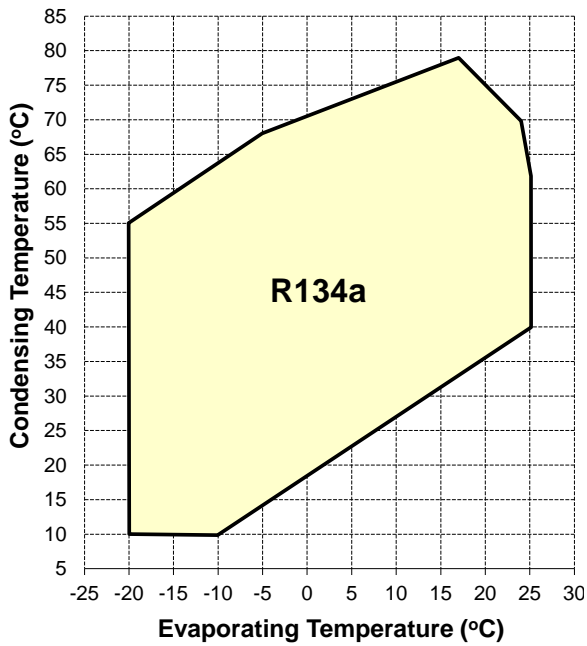

Figure 14: High temp 4M* @ 50% - R134a (1 capacity control)

20K Superheat

4MF-13X, 4ML-15X, 4MM-20X
4MT-22X, 4MU-25X

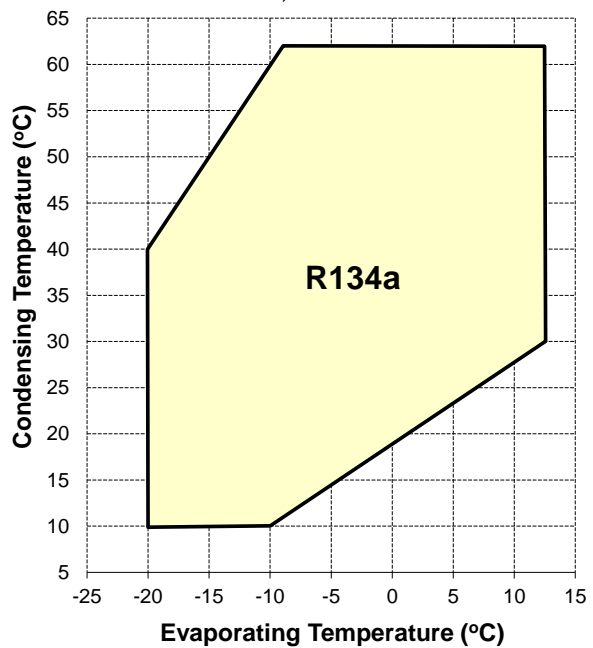

Figure 15: Medium and high temp 4M* @ 50% - R134a (1 capacity control)

25°C Suction gas return

6MI-40X, 6MJ-45X, 6MK-50X

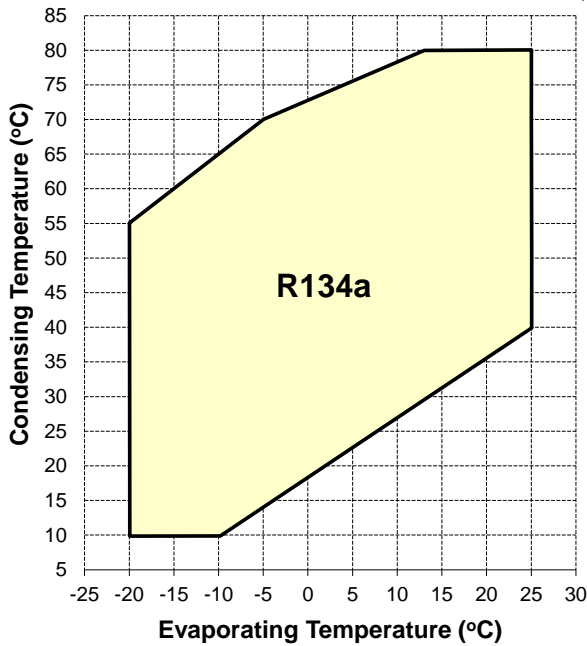

Figure 16: High temp 6M* @ 66% - R134a (1 capacity control)

20K Superheat

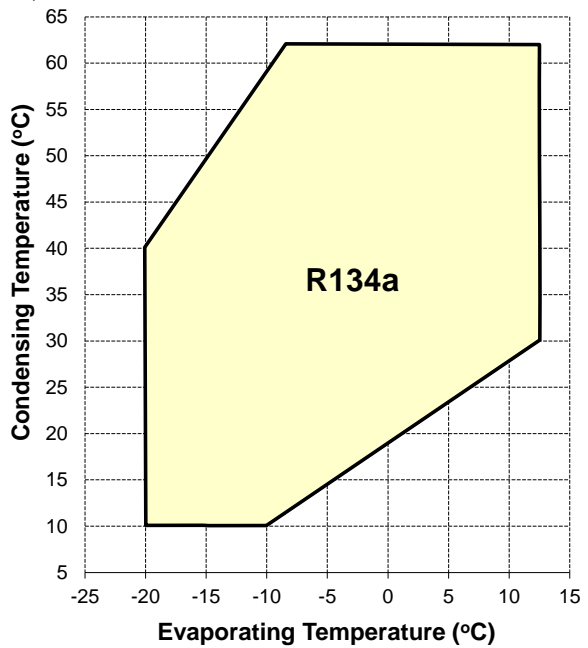

Figure 17: High temp 6M* @ 33% - R134a (2 capacity controls)

6MM-30X, 6MT-35X, 6MU-40X

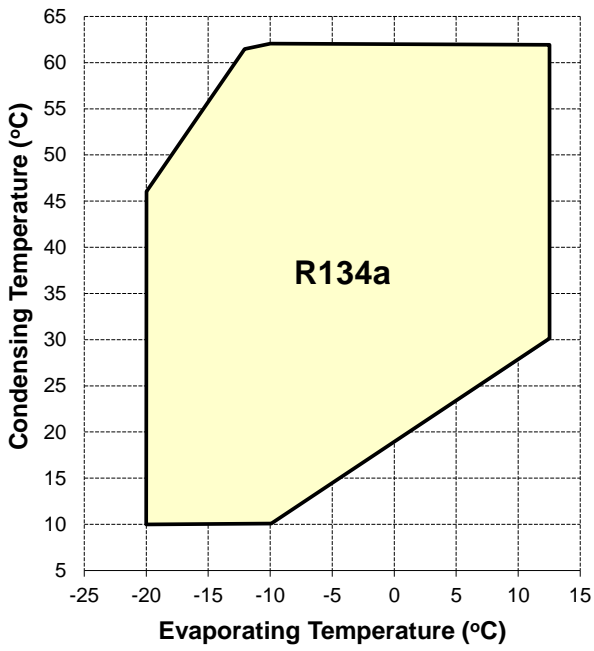

Figure 18: Medium and High temp. 6M* @66% - R134a (1 capacity control)

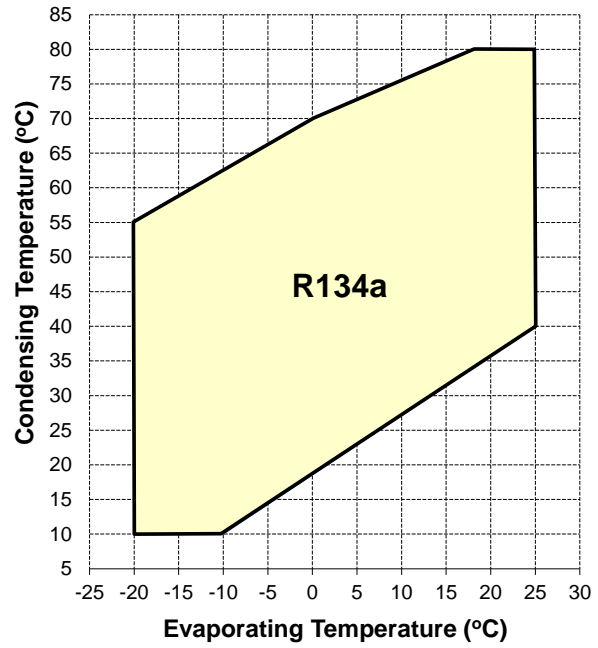

Figure 19: Medium and High temp. 6M* @33% - R134a (2 capacity controls)

25°C Suction gas return

2.5 Capacity control with R407A

2.5.1 Capacity control selection

Compressor	Number of cylinders with capacity control	Capacity regulation step			Remaining refrigeration capacity % (average values)		Remaining power input % (average values)		Figure nr
		0	1	2	Application range				
					HM	ML	HM	ML	
4MA-22X	2	100%	50%		50		56		20
4MH-25X	2	100%	50%		50		56		20
4MI-30X	2	100%	50%		45		50		20
4MJ-30X	2	100%	50%		45		50		20
4MK-32X	2	100%	50%		50		56		20
4MF-13X	2	100%	50%			49		53	21
4ML-15X	2	100%	50%			49		53	21
4MM-20X	2	100%	50%			49		53	21
4MT-22X	2	100%	50%			49		53	21
4MU-25X	2	100%	50%			49		53	21
6MI-40X	2/4	100%	66%	33%	67/34		69/35		22/23
6MJ-45X	2/4	100%	66%	33%	67/34		69/35		22/23
6MK-50X	2/4	100%	66%	33%	67/34		69/35		22/23
6MM-30X	2/4	100%	66%	33%		67/34		69/36	24/25
6MT-35X	2/4	100%	66%	33%		67/34		69/36	24/25
6MU-40X	2/4	100%	66%	33%		67/34		69/36	24/25

Table 3: R407A Capacity control selection table

2.5.2 R407A Application range

4MA-22X, 4MH-25X, 4MI-30X
4MJ-33X, 4MK-35X

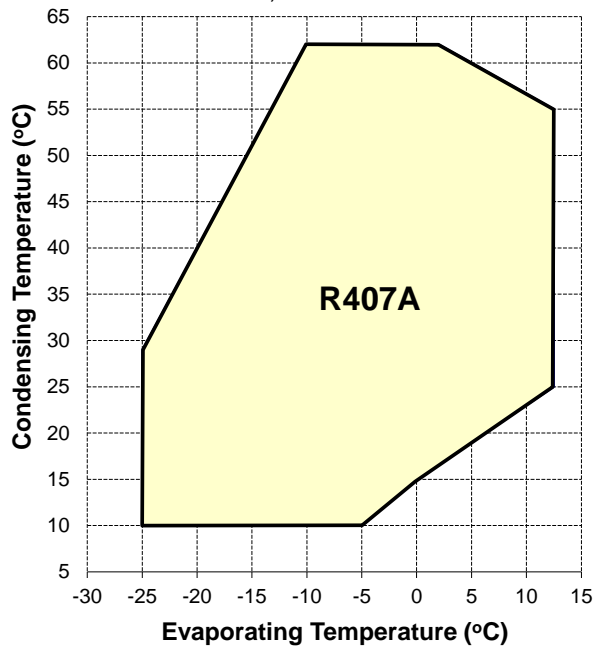

Figure 20: Medium & high temp 4M* @ 50% (1 capacity control)

4MF1-13X, 4ML1-15X, 4MM1-20X
4MT1-22X, 4MU1-25X

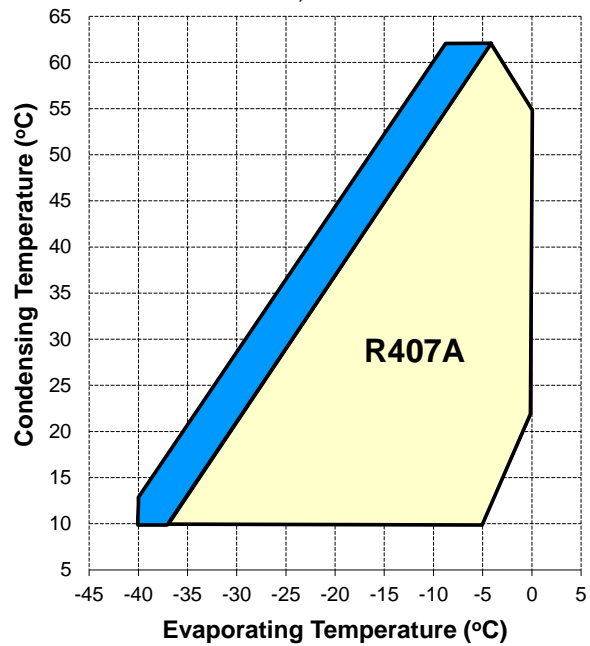

Figure 21: Low and medium temp 4M* @ 50% (1 capacity control)

20°C Suction gas return
 0°C Suction gas return

6MI1-40X, 6MJ1-45X, 6MK1-50X

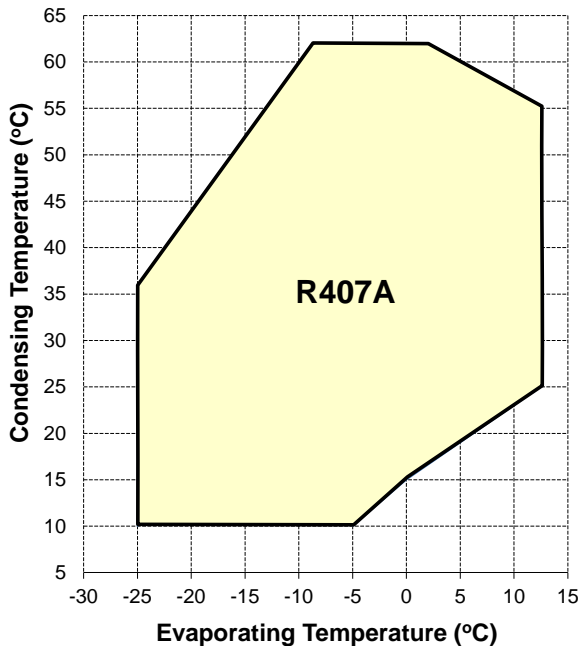

Figure 22: Medium & high temp 6M* @ 66%
(1 capacity control)

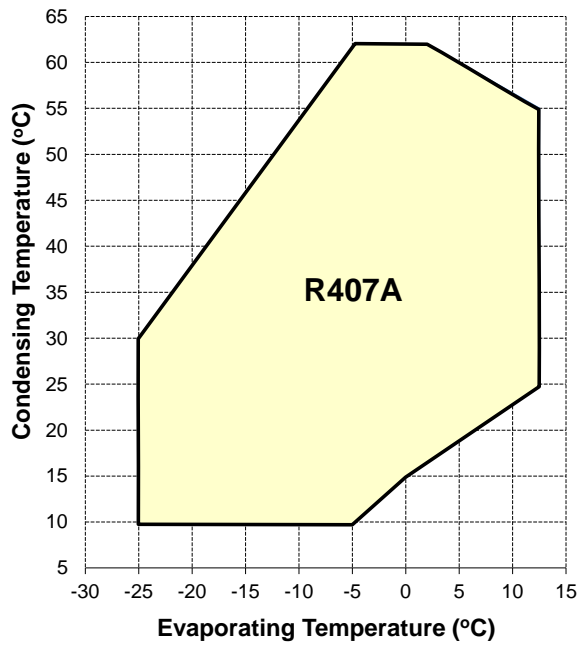



Figure 23: Medium & high temp 6M* @ 33%
(2 capacity controls)

 20°C Suction gas return

6MM1-30X, 6MT1-35X, 6MU1-40X

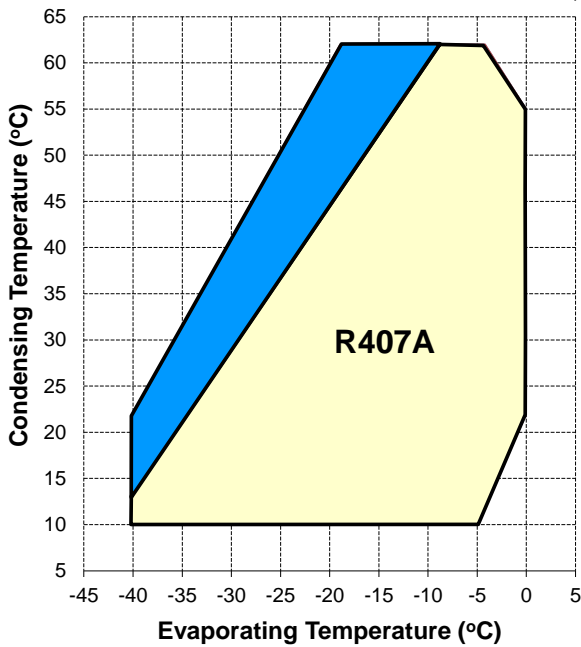

Figure 24: Low and medium temp 6M* @ 66%
(1 capacity controls)

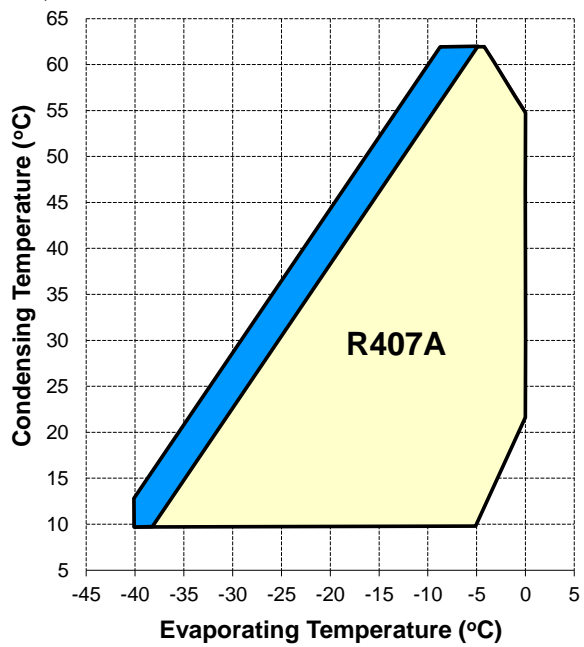



Figure 25: Low and medium temp 6M* @ 33%
(2 capacity controls)

 20°C Suction gas return
 0°C Suction gas return

2.6 Capacity control with R407F

2.6.1 Capacity control selection

Compressor	Number of cylinders with capacity control	Capacity regulation step			Remaining refrigeration capacity % (average values)		Remaining power input % (average values)		Figure nr
		0	1	2	Application range				
					HM	ML	HM	ML	
4MA-22X	2	100%	50%		50		54		26
4MH-25X	2	100%	50%		50		54		26
4MI-30X	2	100%	50%		50		54		26
4MJ-30X	2	100%	50%		50		54		26
4MK-32X	2	100%	50%		50		54		26
4MF-13X	2	100%	50%			50		55	27/28
4ML-15X	2	100%	50%			50		55	27/28
4MM-20X	2	100%	50%			50		55	27/28
4MT-22X	2	100%	50%			50		55	27/28
4MU-25X	2	100%	50%			50		55	27/32
6MI-40X	2/4	100%	66%	33%	68/33		69/38		29/30
6MJ-45X	2/4	100%	66%	33%	68/33		69/38		29/30
6MK-50X	2/4	100%	66%	33%	68/33		69/38		29/30
6MM-30X	2/4	100%	66%	33%		69/33		69/38	31/32/33/34
6MT-35X	2/4	100%	66%	33%		69/33		69/38	31/32/33/34
6MU-40X	2/4	100%	66%	33%		69/33		69/38	31/32/33/34

Table 4: R407F Capacity control selection table

2.6.2 R407F Application range

4MA-22X, 4MH-25X, 4MI-30X
4MJ-33X, 4MK-35X

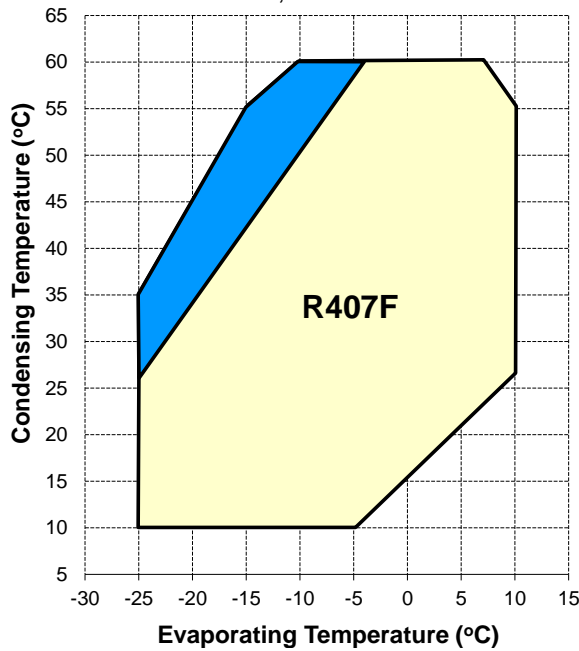

Figure 26: Medium & high temp 4M* @ 50% (1 capacity control)

4MF-13X, 4ML-15X, 4MM-20X
4MT-22X, 4MU-25X

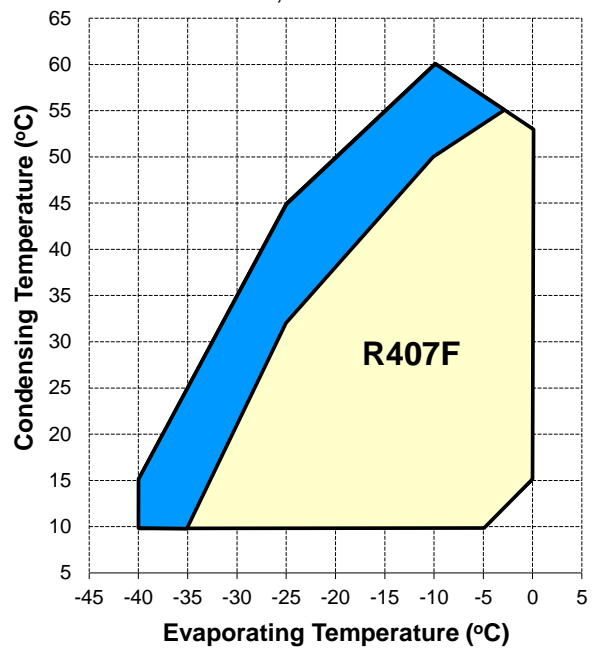
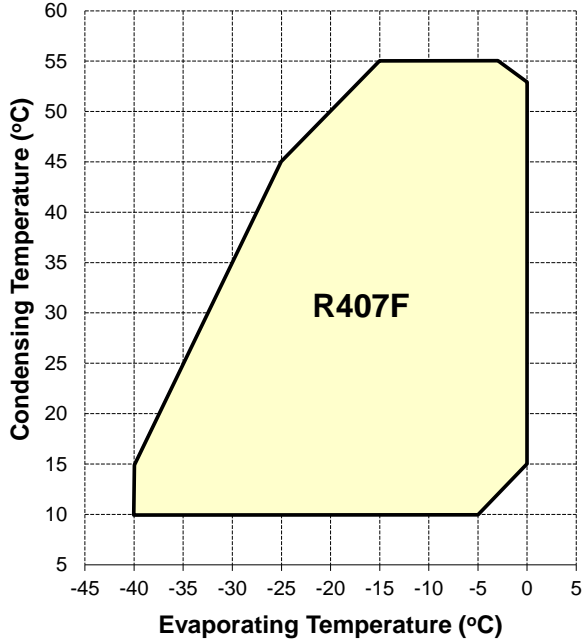

Figure 27: Low and medium temp 4M* @ 50% (1 capacity control)

20°C Suction gas return
 0°C Suction gas return

4MF-13X, 4ML-15X, 4MM-20X, 4MT-22X, 4MU-25X with Demand Cooling



20°C Suction gas return + Liquid injection

Figure 28: Low & medium temp 4M* @ 50% (1 capacity control)

6MI-40X, 6MJ-45X, 6MK-50X

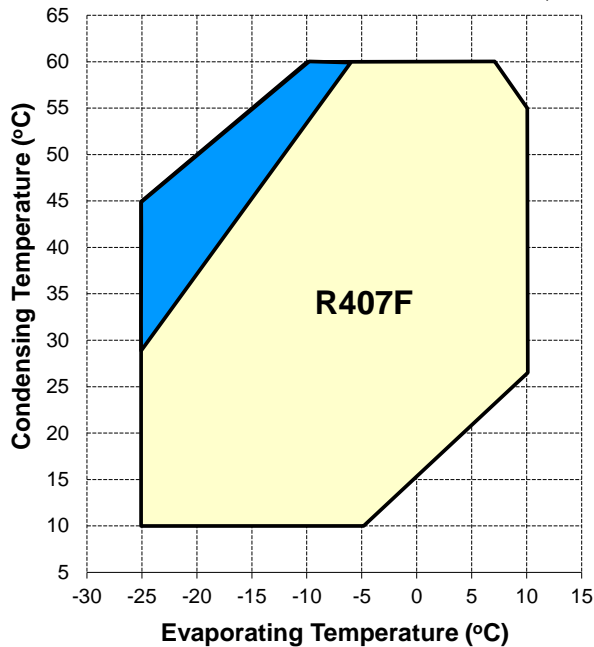

Figure 29: Medium & high temp 6M* @ 66% (1 capacity control)

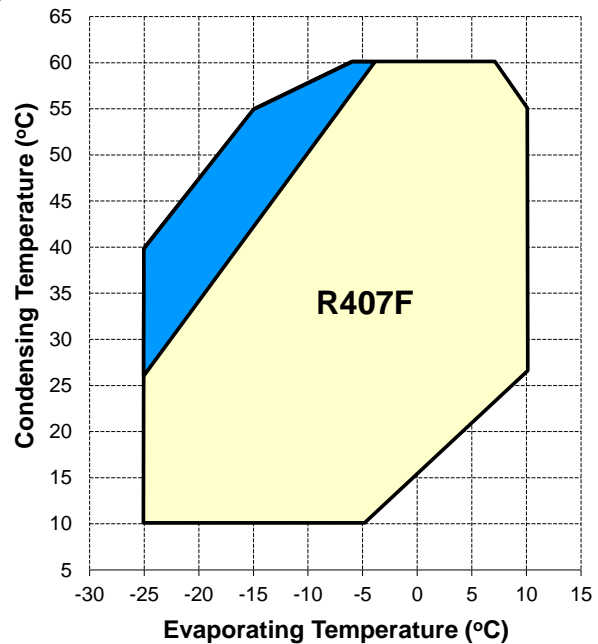

Figure 30: Medium & high temp 6M* @ 33% (2 capacity controls)

20°C Suction gas return
 0°C Suction gas return

6MM-30X, 6MT-35X, 6MU-40X

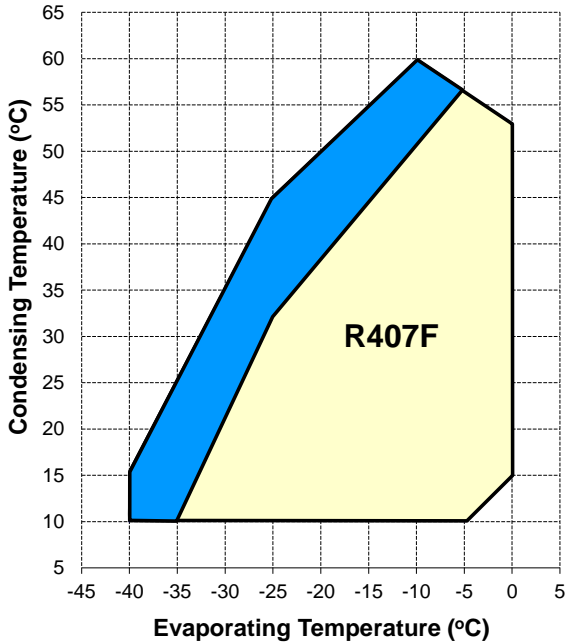

Figure 31: Low & medium temp 6M* @ 66%
(1 capacity controls)

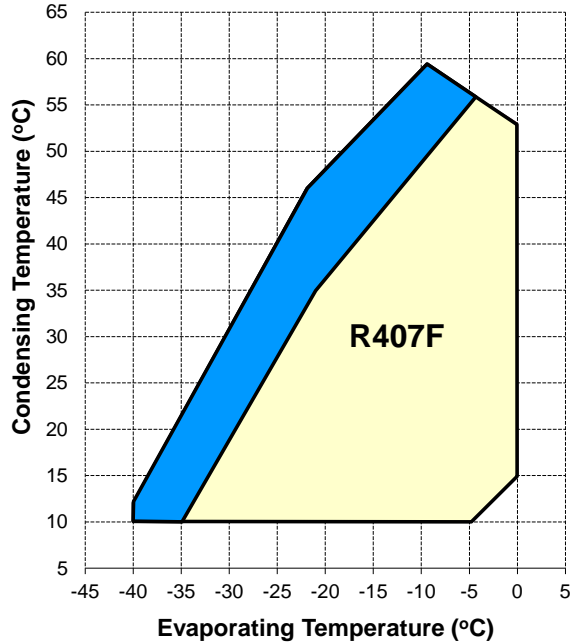

Figure 32: Low & medium temp 6M* @ 33%
(2 capacity controls)

20°C Suction gas return
 0°C Suction gas return

6MM-30X, 6MT-35X, 6MU-40X
with Demand Cooling

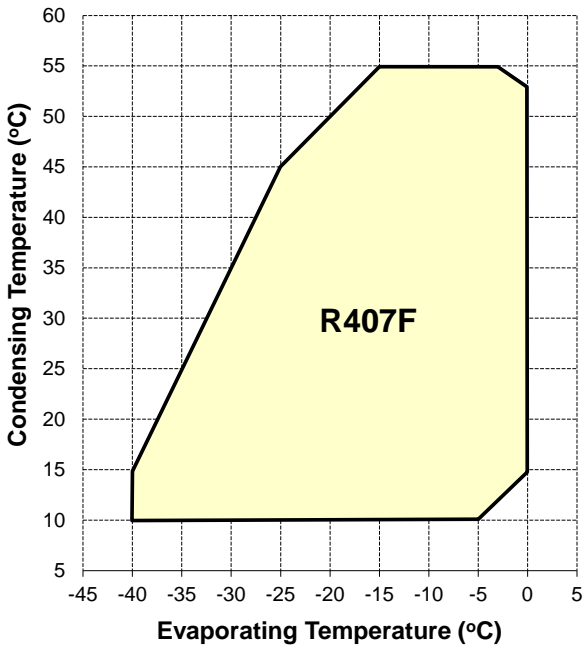

Figure 33: Low and medium temp 6M* @ 66%
(1 capacity control)

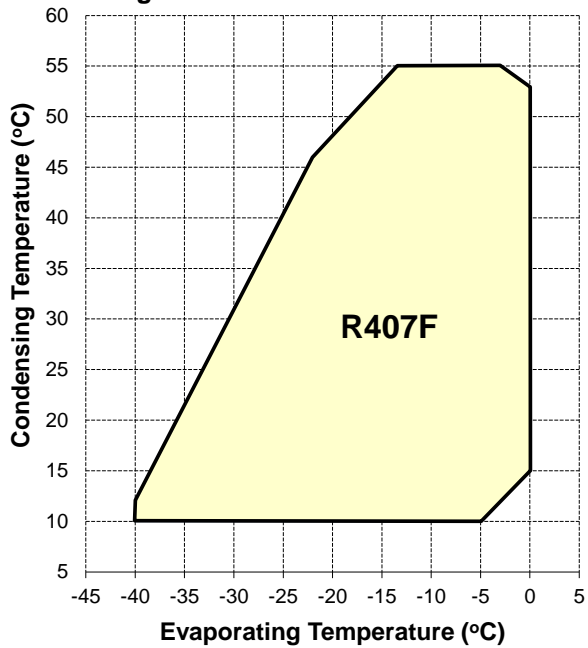

Figure 34: Low and medium temp 6M* @ 33%
(2 capacity controls)

20°C Suction gas return + Liquid injection

2.7 Capacity control with R407C

2.7.1 Capacity control selection

Compressor	Number of cylinders with capacity control	Capacity regulation step			Remaining refrigeration capacity % (average values)		Remaining power input % (average values)		Figure Nr
		0	1	2	Application range				
					HM	ML	HM	ML	
4MA-22X	2	100%	50%		48		54		35
4MH-25X	2	100%	50%		48		54		35
4MI-30X	2	100%	50%		48		54		35
4MJ-30X	2	100%	50%		48		54		35
4MK-32X	2	100%	50%		48		54		35
6MI-40X	2/4	100%	66%	33%	67/33		69/38		36/37
6MJ-45X	2/4	100%	66%	33%	67/33		69/38		36/37
6MK-50X	2/4	100%	66%	33%	67/33		69/38		36/37

Table 5: R407C Capacity control selection table

2.7.2 R407C Application range

4MA-22X, 4MH-25X, 4MI-30X,
4MJ-33X, 4MK-35X

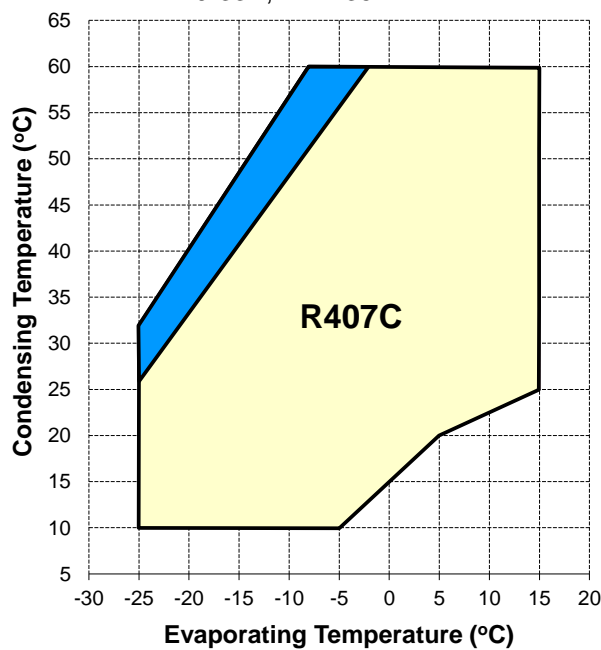



Figure 35: Medium & high temp 4M* @ 50%
(1 capacity control)

-  20°C Suction gas return
-  0°C Suction gas return

6MI-40X, 6MJ-45X, 6MK-50X

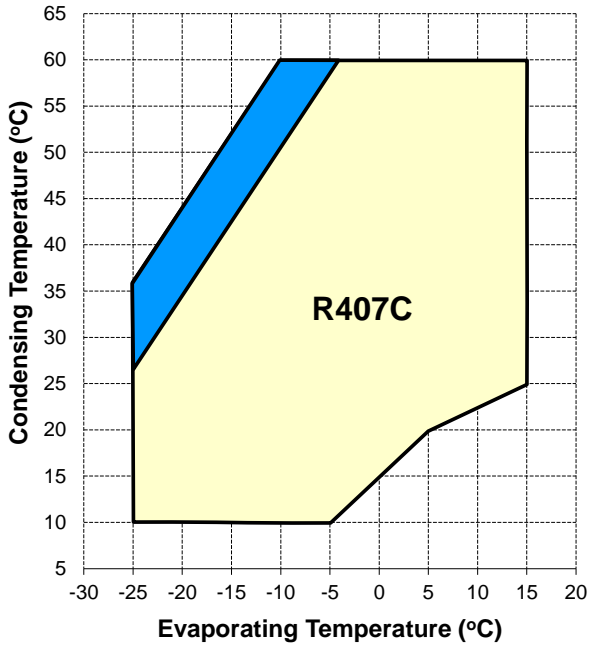

Figure 36: Medium & high temp 6M* @ 66%
(1 capacity control)

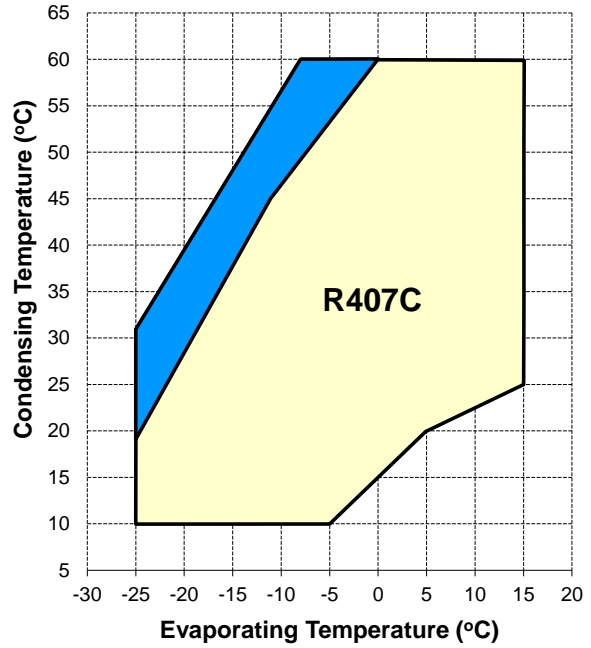
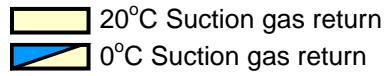

Figure 37: Medium & high temp 6M* @ 33%
(2 capacity controls)



Information in this document is subject to change without notice.