



**Cella Range**  
Solutions for cold rooms

**Connected** Efficiency

# Cella Range - platform for cold room solutions

A wide range of integrated and inter-communicating controllers and accessories that maximise system efficiency and energy saving and preserve the value of the goods stored, with special focus on simple installation and configuration and user convenience.

- Complete control of all cold room devices;
- Complies with HACCP standards;
- Temperature/humidity management;
- Management of electronic expansion valves;
- Integration with DC inverter solutions;
- All-in-one or remote power management (serial);
- Integrated safety devices and advanced supervision.

## CellaRange

A range of modular products for complete management of cold rooms, which can be combined so as to best adapt to system specifications, are easily expandable and can also be integrated into retrofit applications.



### 1ph/3ph power modules

Power modules for managing single-phase and/or three-phase loads; modular and/or remote connection (RS485).

### EVD modules

EVD modules for electronic valve management; modular and/or remote connection (RS485).



### Usability

Faster installation and commissioning thanks to error-proof wiring, device pre-configuration and integration with advanced interfaces (multilingual graphics and text).



### Efficiency

Up to 30% energy savings compared to traditional systems by using the electronic stepper valve. Further advantages in combination with condensing units based on CAREL DC inverter technology.



### Product quality

Minimum variation in product storage temperature and total control of humidification in the cold room, with safety guaranteed by the CAREL supervision platform.

## exu sistema



Electronic stepper expansion valves, in inspectable or welded versions, available for different types of applications or refrigerants, including CO<sub>2</sub>

up  
**30%**  
energy saving

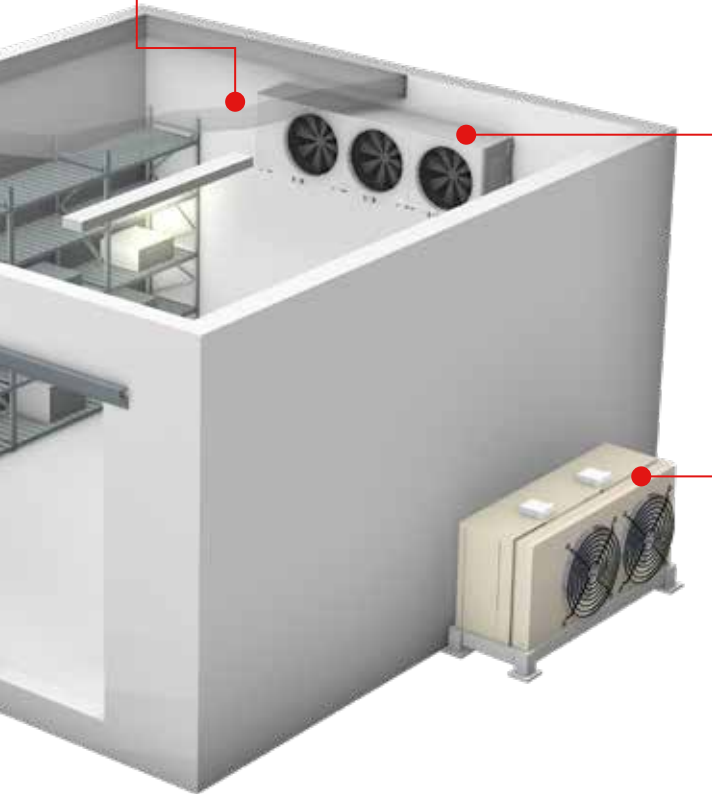

## eVDice

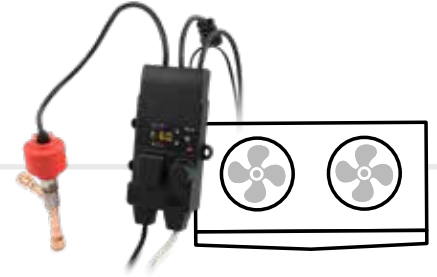

### Invented for cold environments

Ready-to-install solution: evaporator complete with electronic expansion valve and driver, pre-assembled, wired and tested by the manufacturer.

\* Ask your dealer for evaporators with CAREL technology

## HECU\*



### The real capacity modulation technology for condensing units

Solution for variable-speed condensing units, based on DC inverter technology for applications with HFCs, HFOs and natural refrigerants (CO<sub>2</sub>).

\* Ask your dealer for condensing units with CAREL technology

## BOSS mini

### Mobile-ready local supervisor with built-in WiFi

Intuitive and customisable interface, fully compatible with mobile devices. New alarm notification channels via instant messaging.



## Probes and sensors



Wide range of temperature and humidity probes and pressure transducers to manage different types of applications.

## Accessories



**ColdWatch**  
Trapped personnel alarm.



**Leakage sensor**  
Refrigerant gas leakage sensor.



**humiDisk**  
Cold room humidity management.

# High-efficiency integrated systems

## Electronic valve driver mounted on the evaporator

### eVDice

- zero** wiring and welding  
EEV and drivers already fitted on the evaporator and tested.
- three** parameters only for set-up  
Simple and fast configuration, even via remote (RS485).
- half** pull-down time  
Cold room operating in half the time.

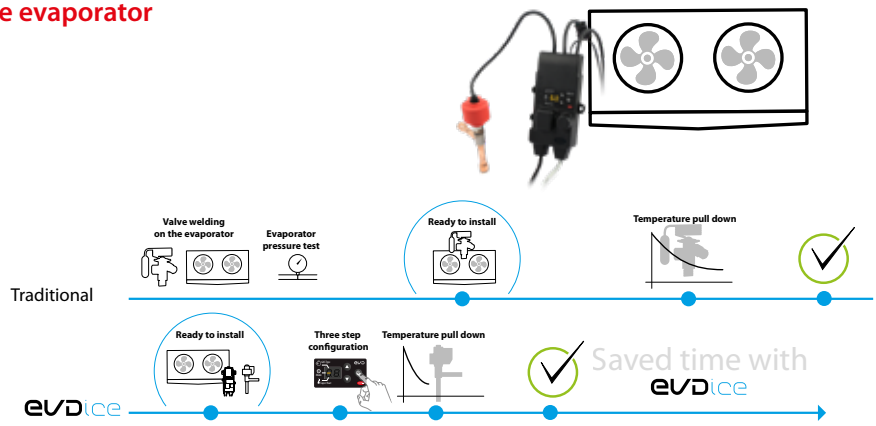

Estimated savings in installation time and configuration of an evaporator with EVD Ice compared to traditional technology.

## Technology for the management of electronic expansion valves

### exvsystema

- High efficiency and energy savings.
- Reduced configuration, commissioning and maintenance times.
- Suitable for all types of refrigerant.

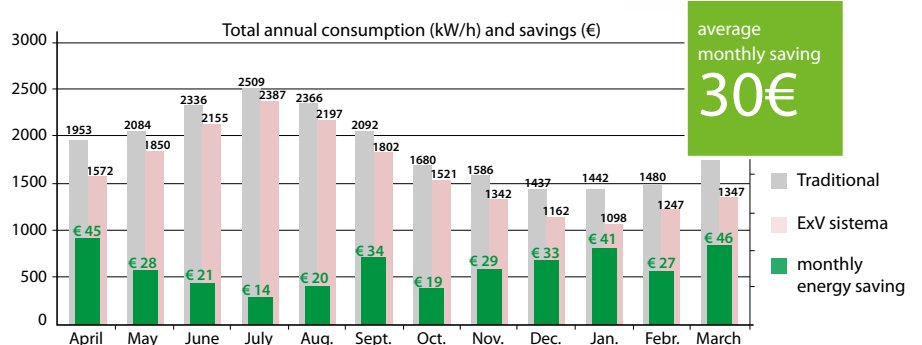

Total annual energy consumption based on a 90m<sup>3</sup> LT cold room, comparison between EEV and TEV technology (energy savings valued @ 0.12 €/kW/h).  
For more information, see Marketing News [+4000057EN](#) on [www.carel.com](#).

## Modules for direct and remote management of three-phase loads

### Cella 3PH SOLUTION

- Range of modules for the management of three-phase compressors, defrosts and fans, ready to install.
- Reduced installation times and costs



Example of installation of a remote power module compared to a traditional three-phase solution. In a cold room measuring 2.5 m x 5 m x 16 m, the CAREL solution can save up to 34 metres of power cable (and consequent installation time and costs), exploiting the connection via simple RS485 signal cable between UltraCella and the three-phase power module.

## Capacity modulation technology for condensing units

**HEcu**



High efficiency and energy savings.



Maximum reliability also ensured by compressor envelope and oil return management.



Preservation of stored product quality and value.

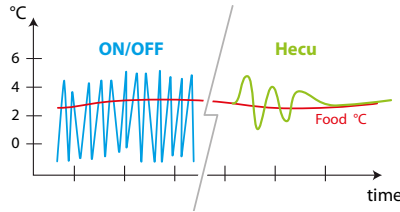

Comparison between the storage temperature in a traditional system based on ON/OFF compressor management and a modulating system based on HECU DC inverter technology. In the latter case, the cold room temperature remains within a range of  $\pm 1^\circ\text{C}$  around the set point for over 80% of the total time (including defrosting).

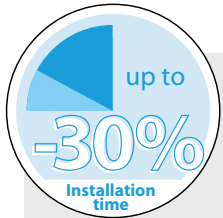

# DC Cella SPLIT

Cold room reinvented, out of the box



### Cold room timeline: from installation to steady operating conditions

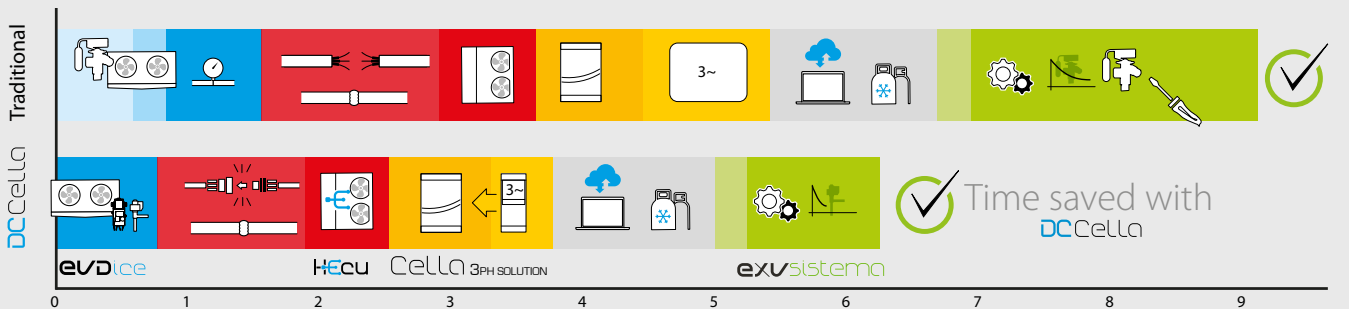

Estimated INSTALLATION + COMMISSIONING time (hours)

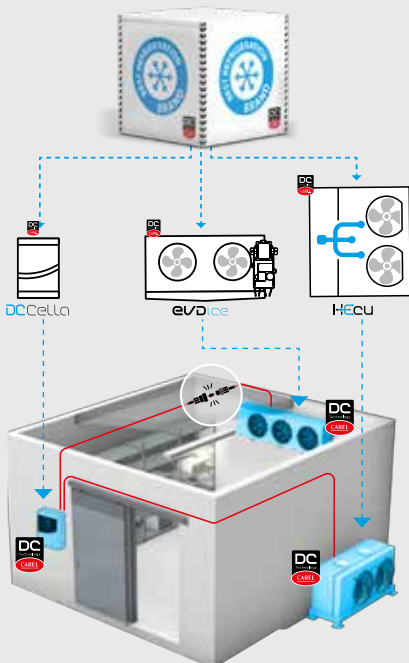

DC Cella SPLIT is the new solution for high performance cold rooms. Based on the experience acquired from innovative products such as Hecu, EVD ice and UltraCella, DC Cella SPLIT combines the high performance of DC inverter applications and CO<sub>2</sub> technology with the installation simplicity of a home air-conditioner.

An integrated system with real-time management of evaporators and condensing units, with the same easy installation and use as a traditional product.

CO<sub>2</sub> up to **15%**  
Energy saving  
CO<sub>2</sub> vs AC inv

















































































up to **25%**  
Energy saving  
HFC vs AC inv

Optimal food  
preservation

up to **<30db\***  
low noise and less  
vibrations

\* Ask your dealer for cold room solutions with CAREL technology

# Part number guide

Type of compressor	Management of evaporator loads	Cold room controller		Advanced functions	Application diagram (on next page)	Main controller		
		Relays	Protection functions			Cold room controller	Service display (opt.)	Control/defrost probes
	-	1	-		1	WE00S***00 SmartCella	-	NTCO*****
	 	3	-		5	MD33A***00 MasterCella	-	NTCO***** (2x)
		4	-		1	WE00C***00 SmartCella	-	NTCO***** (2x)
					2	WE00C***00 SmartCella	-	NTCO***** (2x)
		5	-		5	MD33D***00 MasterCella	-	NTCO***** (2x)
		6	-	   	3/14	WB000**0F0 UltraCella	PGDEWB0FZK	NTCO***** (2x)
				   	4/14	WB000**0F0 UltraCella	PGDEWB0FZK	NTCO***** (2x)
	 	4			6	WE00C***00 SmartCella	-	NTCO***** (2x)
		6		   	8/14	WB000**0F0 UltraCella	PGDEWB0FZK	NTCO***** (2x)
	 	4	    		7	WE00C***00 SmartCella	-	NTCO***** (2x)
		6	    	   	9/14	WB000**0F0 UltraCella	PGDEWB0FZK	NTCO***** (2x)
			   	    	10/14	WB000**0F0 UltraCella	PGDEWB0FZK	NTCO***** (2x)
	 	5	      	 	11	WP00E****U0 SmartCella 3PH EVD	-	NTCO***** (2x)
		5		12	WP00E****00 SmartCella 3PH	-	NTCO***** (2x)	
	 	6	     	     	13/14	WB000**0F0 UltraCella	PGDEWB0FZK	NTCO***** (2x)

## Key



single-phase compressor or solenoid valve/condensing unit enabling signal



single-phase evaporator fans



defrost + fan four-pole circuit breaker



three-phase compressor



three-phase evaporator fans



defrost four-pole circuit breaker



single phase defrost



residual-current circuit breaker



Kriwan









three-phase defrost



controller protection fuse

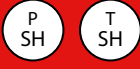

evaporator fan thermal protection

Load management	Electronic valve management			Accessories (optional)				
	Power module	EVD module	Electronic valve	Valve probes	Humidity management	Connectivity card	Supervision	Safety
-								
-	WM00E*S*00 EVDIS00**0	E2V**Z**** E2VCABS*10	NTC0**HF03; SPKT00*; SPKC00*	-	IROPZSER30	BMEST0**** boss mini	CM0000**** Coldwatch	
-	WM00EUC000 EVDIS00**0	E2V**Z**** E2VCABS*10	NTC0**HF03; SPKT00*; SPKC00*	-	IROPZSEM30	BMESTPWA00 power supply	GDW****A00 refrigerant gas	
-	WM00E*S*00 EVDIS00**0	E2V**Z**** E2VCABS*10	NTC0**HF03; SPKT00*; SPKC00*	-	IROPZSER30			
WM00P000*N protection	WM00E*S*00 EVDIS00**0	E2V**Z**** E2VCABS*10	NTC0**HF03; SPKT00*; SPKC00*	-	IROPZSER30			
-	WM00EUC000 EVDIS00**0	E2V**Z**** E2VCABS*10	NTC0**HF03; SPKT00*; SPKC00*	-	IROPZSEM30			
-	WM00E*N*00 (14)	E2V**Z**** E2VCABS*10	NTC0**HF03; SPKT00*; SPKC00*	DPPC***000 humidity probe	included			
WM00P000*N protection	WM00E*N*00 (14)	E2V**Z**** E2VCABS*10	NTC0**HF03; SPKT00*; SPKC00*	UC0**0D*00 humiDisk				
WT00SD00N0 Direct 3ph	WM00E*S*00 EVDIS00**0	E2V**Z**** E2VCABS*10	NTC0**HF03; SPKT00*; SPKC00*	-	IROPZSER30			
WT00SD00N0 Direct 3ph	WM00E*N*00 (14)	E2V**Z**** E2VCABS*10	NTC0**HF03; SPKT00*; SPKC00*	DPPC***000 humidity probe UC0**0D*00 humiDisk	included			
WT00CDG0N0 Direct 3ph	WM00E*S*00 EVDIS00**0	E2V**Z**** E2VCABS*10	NTC0**HF03; SPKT00*; SPKC00*	-	IROPZSER30			
WT00CDG0N0 3ph direct	WM00E*N*00 (14)	E2V**Z**** E2VCABS*10	NTC0**HF03; SPKT00*; SPKC00*	DPPC***000 humidity probe	included			
WT00E*00N0 3ph remote	WM00E*N*00 (14)	E2V**Z**** E2VCABS*10	NTC0**HF03; SPKT00*; SPKC00*	UC0**0D*00 humiDisk				
included	incluso (aggiungere EVDIS00**0)	E2V**Z**** E2VCABS*10	NTC0**HF03; SPKT00*; SPKC00*	-	IROPZSER30			
included	-	-	-	-	IROPZSER30			
WT00F**0N0 3ph remote	WM00E*N*00 (14)	E2V**Z**** E2VCABS*10	NTC0**HF03; SPKT00*; SPKC00*	DPPC***000 humidity probe UC0**0D*00 humiDisk	included			

(14): for cold rooms with two evaporators, two driver modules are required, including at least one WM00E\*S\*00 with EVDIS00\*\*0 display + two electronic valves + two pressure transducers and cables + two temperature sensors.



defrost safety thermostat



energy saving



remote power management



high/low pressure switch



advanced energy saving



datalogger function (USB)



main disconnect switch



built-in serial connectivity



humidification/dehumidification management



adjustable manual motor starter  
(compressor)



condenser fan management

# 1ph cold rooms

## 1 SmartCella + EVD module (WE00C\*\*\*00 + WM00E\*S\*00 + EVDIS00\*\*0)

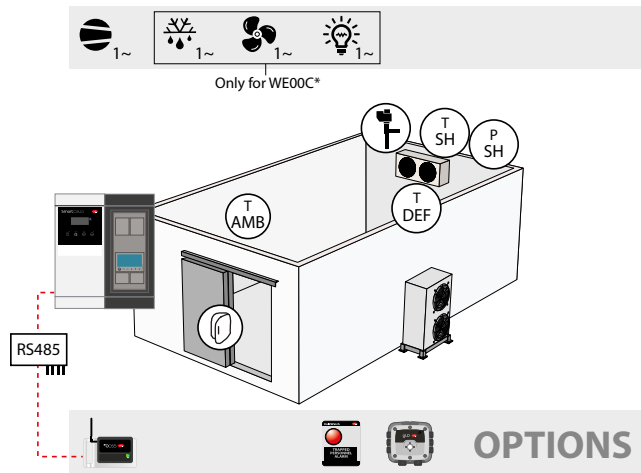

## 2 SmartCella + EVD module + 1ph power module (WE00C\*\*\*00 + WM00E\*S\*00 + EVDIS00\*\*0 + WM00P000\*N)

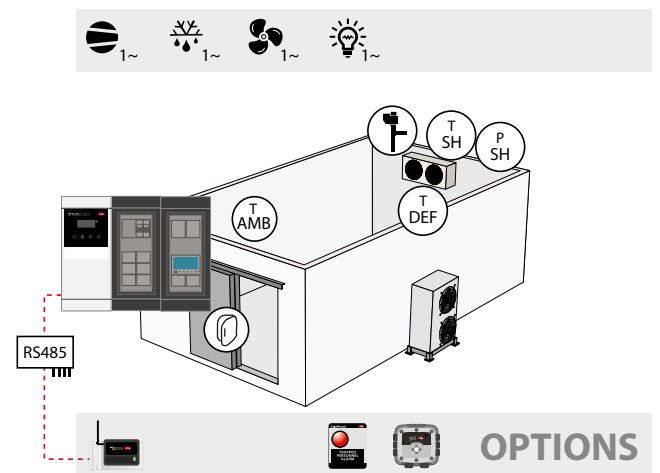

## 3 UltraCella + EVD Module (WB000\*\*0F0 + WM00E\*N\*00)

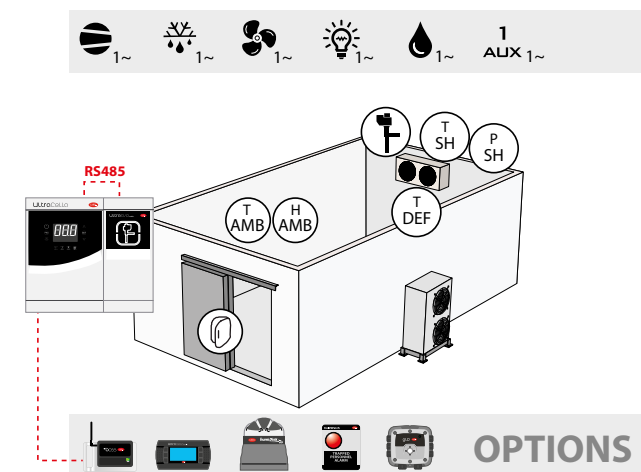

## 4 UltraCella + EVD module + 1ph power module (WB000\*\*0F0 + WM00E\*N\*00 + WM00P000\*N)

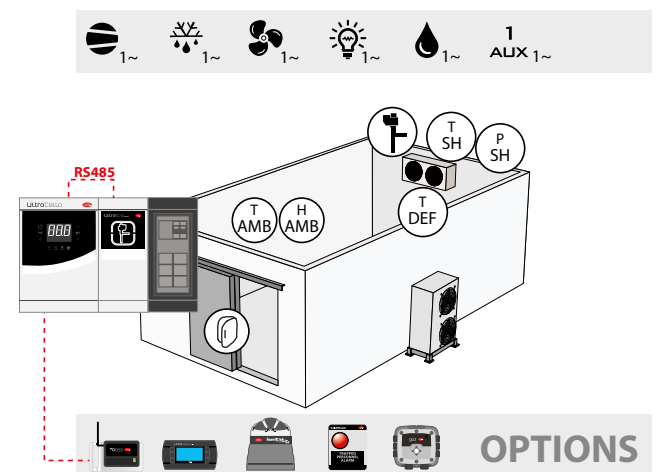

## 5 MasterCella + EVD Module (MD33D\*\*\*00 + WM00EUC000 + EVDIS00\*\*0)

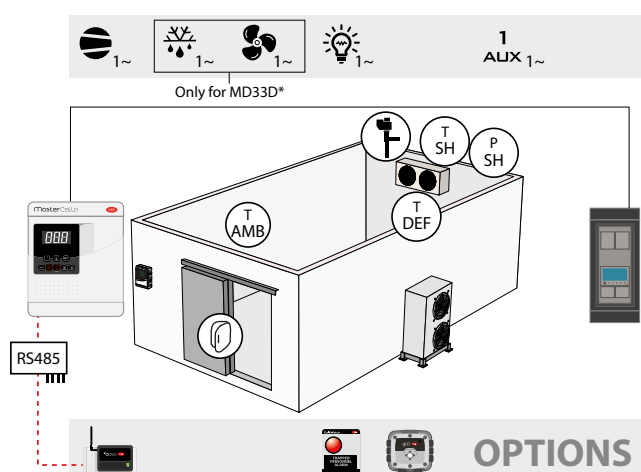

See diagram 14 for cold rooms with two evaporators.



# 1 ph cold rooms with 3ph defrost and fans

**6 SmartCella + EVD module + 3ph power module (defrost)**  
 (WE00C\*\*\*00\* + WM00E\*S\*00+EVDIS00\*\*0 + WT00SD00N0)

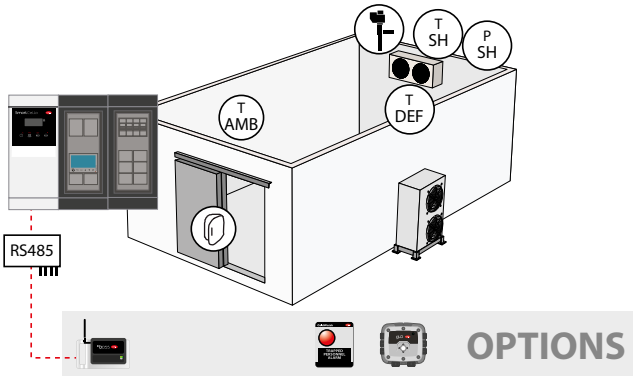
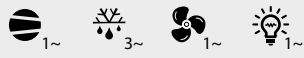

**7 SmartCella + EVD module + 3ph power module (defrost + fans)**  
 (WE00C\*\*\*00 + WM00E\*S\*00+EVDIS00\*\*0 +WT00CDG0N0)

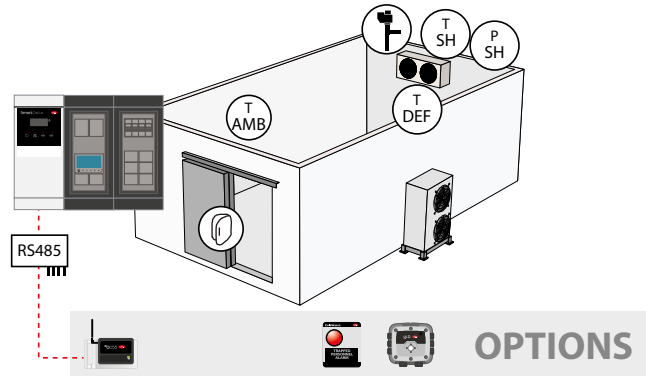
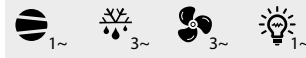

**8 UltraCella + EVD module + 3ph power module (defrost)**  
 (WB000\*\*0F0 + WM00E\*N\*00 + WT00SD00N0)

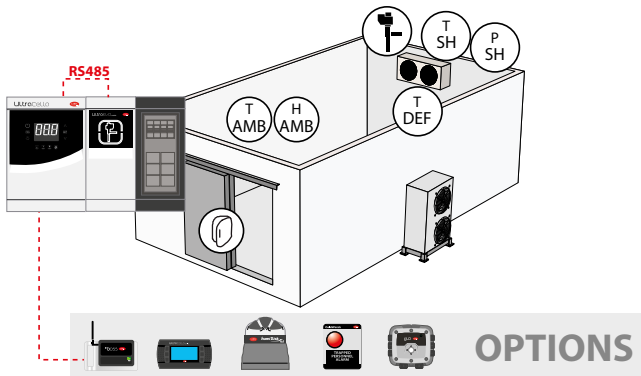

**9 UltraCella + EVD module + 3ph power module (defrost + fans)**  
 (WB000\*\*0F0 + WM00E\*N\*00 + WT00CDG0N0)

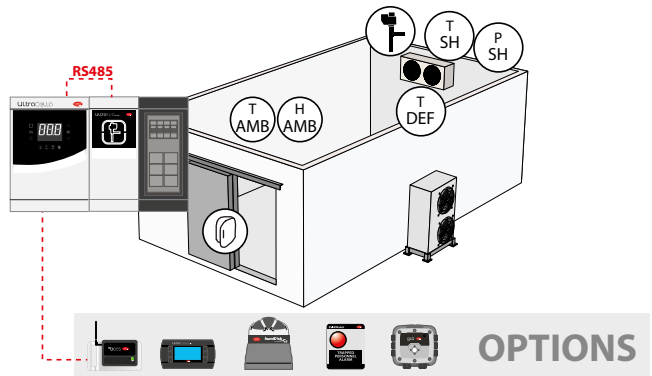

**10 UltraCella + EVD module + Remote 3ph power module (evaporator)**  
 (WB000\*\*0F0 + WM00E\*N\*00 + WT00E\*00N0)

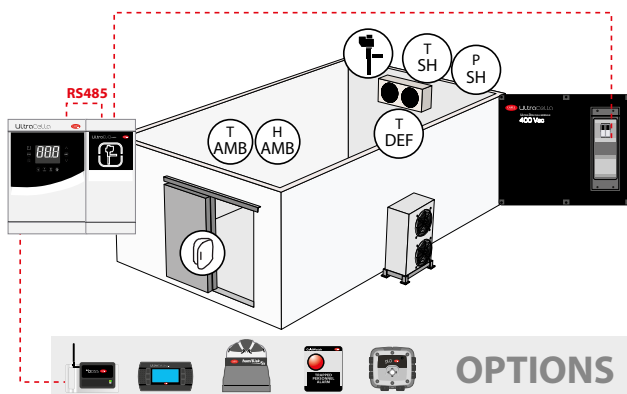

See diagram 14 for cold rooms with two evaporators.

# 3ph cold rooms

## 11 SmartCella 3PH EVD (WP00E\*\*\*\*U0 + EVDIS00\*\*0)

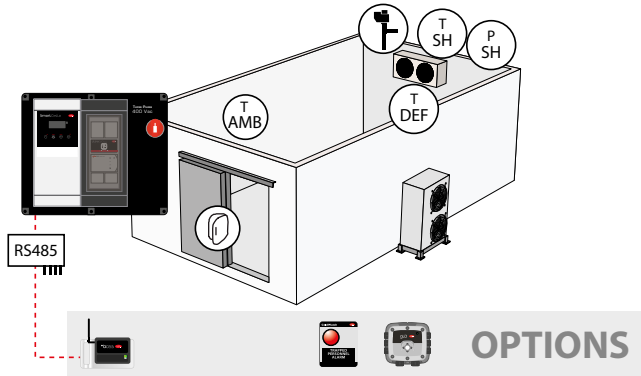

## 12 SmartCella 3PH (WP00E\*\*\*\*00)

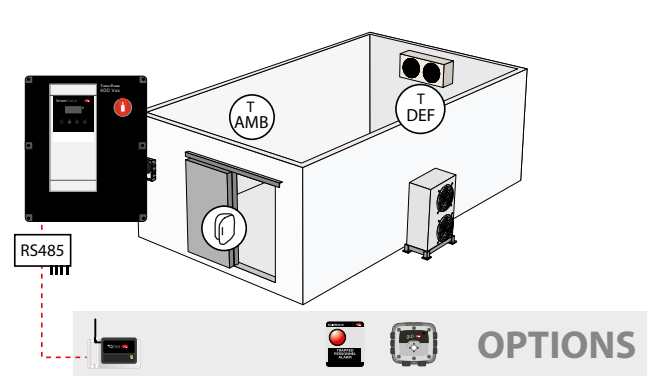

## 13 UltraCella + EVD module + Remote 3ph power module (full) (WB000\*\*0F0 + WM00E\*N\*00 + WT00F\*\*0N0)

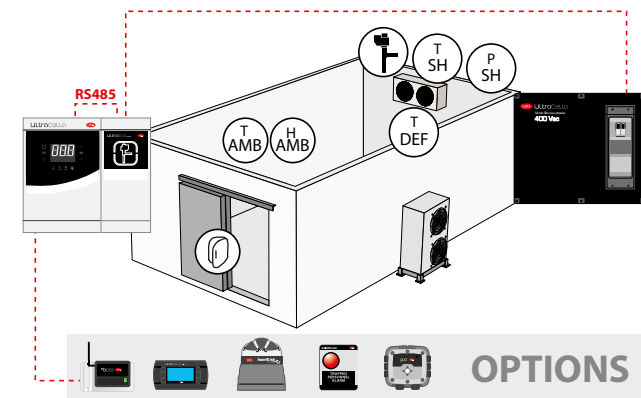

# 3ph cold rooms with two evaporators

## 14 UltraCella + 2 EVD modules + Remote 3ph power module (full) (WB000\*\*0F0 + WM00E\*\*\*00 + WM00E\*S\*00 + EVDIS00\*\*0 + WT00F\*\*0N0) (For cold rooms with two evaporators)

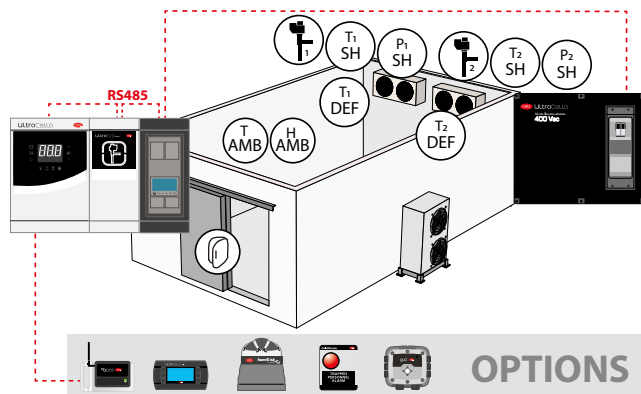

(14): for cold rooms with two evaporators, two driver modules are required, including at least one WM00E\*S\*00 with EVDIS00\*\*0 display + two electronic valves + two pressure transducers and cables + two temperature sensors.



# UltraCella



IP65 cold room front panel, 6 relays with power up to 2 HP. Defrost by compressor stop, heater or hot gas. USB datalogging function. Humidification/dehumidification and dual evaporator management. Can be combined with two EVD modules for managing two electronic valves and direct or remote power modules for three-phase load management. Can be connected to supervision system via built-in RS485. Can interface with condensing units using CAREL DC INVERTER technology.

**NEW** Software release 3.x

### Accessories

PGDEWB0FZK:  
UltraCella Service  
Terminal + cable



### Plus



Specifications	WB000SG0F0	WB000SW0F0	WB000DG0F0	WB000DW0F0
Main	Single line display, Green LED	Single line display, White LED	Two line display, Green LED	Two line display, White LED
Dimensions	128x290x100 mm			
Ingress protection	IP65			
Power supply	230 Vac			
Power input	18 VA, 100 mA~ max			
<b>Inputs</b>				
Total	8			
Analogue (type)	3 (NTC, PT1000), 1 (NTC, 0-10 Vdc), 1 (0-5 Vdc, 4-20 mA)			
Digital (type)	3 (configurable)			
<b>Outputs (EN60730-1/UL873) - sum of load currents max. 20 A</b>				
Compressor	2HP (12(10 A)/12 A res. 12FLA 72LRA C300)			
Defrost	2HP (12(10 A)/12A res. 12FLA 72LRA C300)			
Evaporator fan	16A (10(5)/10 A res. 5FLA 18LRA C300)			
Light	16A (10(5)/10 A res. 5FLA 18LRA C300)			
AUX 1 (configurable)	8A (8(4) on NO, 6(4) on NC, 2(2) on NC and NO/8 A res. 2FLA 12LRA C300)			
AUX 2 (configurable)	8A (8(4) on NO, 6(4) on NC, 2(2) on NC and NO / 8 A res. 2FLA 12LRA C300)			
Analog output	0 to 10 Vdc, 10 mA max			
<b>Additional functions/modules</b>				
Electronic valve management	Optional (with WM00E*N*00 for one evaporator or WM00E*S*00 for two evaporators)			
Residual current circuit breaker	Optional (with WM00P000*N)			
Three-phase power management	Optional (remote with WT00E* or WT00F*, direct with WT00S* or WT00C*)			
<b>Other specifications</b>				
Connectivity (serial) RS485	YES (1 BMS, 1 FieldBus)			
Internal clock	YES			
Datalogger function	YES (USB)			
Humidity management	YES			

### Functional diagram

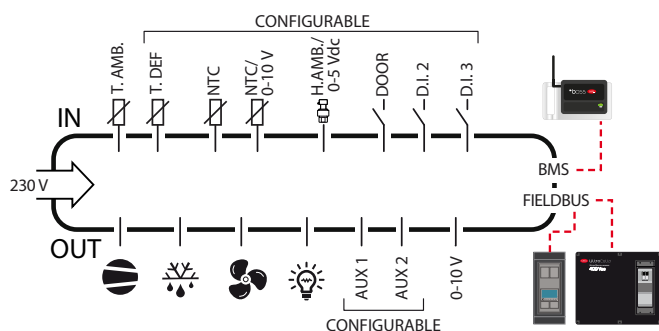

### Product part number

**WB000\_ \_0F0**

display lines:  
S= 1  
D= 2

display colour:  
W= white  
G= green



# SmartCella three-phase



IP65 cold room front panel for three-phase applications, electronic, with 5 configurable relays. Defrost by compressor stop, heater or hot gas. Available in the version with electronic valve driver included. Can be connected to supervision system via RS485 serial card.

### Accessories

IROPZSER30: RS485 serial card for connection to supervision system.



### Plus



Specifications	WP00E11A1*0	WP00E21A1*0	WP00E31A1*0	WP00E41A1*0	WP00E51A1*0	WP00E42A2*0	WP00E62A2*0	WP00E72A2*0	WP00E73B3*0
Main	Three-phase up to 4 HP					Three-phase up to 7.5 HP			Three-phase up to 10 HP
Electronic valve driver	Included in models with *= U (e.g. WP00E11A1U0); not included in models with *= 0 (e.g. WP00E11A100)								
Dimensions	460x380x127 mm								
Ingress protection	IP56								
Power supply	400 Vac								
<b>Protection functions</b>									
Main disconnect switch	40 A								
Compressor (manual motor starter)	1.6 to 2.5 A	2.5 to 4 A	4 to 6.3 A	6.3 to 10 A	8 to 12 A	6.3 to 10 A	10 to 16 A	16 to 20 A	16 to 20 A
Evaporator, condenser, defrost (circuit breaker)	10 A								
Auxiliary circuit (circuit breaker)	6 A								
<b>Inputs</b>									
Totals (electronic controller)	4								
Analogue (type)	2 (NTC/NTC*HT)								
Digital (type)	2 (configurable)								
Other inputs provided (contact)	Safety thermostat (defrost); thermal protection (evaporator fans); compressor Kriwan; high/low pressure switch, pump down								
Fan speed control pressure switch	-								YES
<b>Outputs</b>									
Compressor	1.6 to 2.5 A	2.5 to 4 A	4 to 6.3 A	6.3 to 10 A	8 to 12 A	6.3 to 10 A	10 to 16 A	16 to 20 A	16 to 20 A
Defrost	9000 W - 3ph					9000 W - 3ph			12000 W - 3ph
Evaporator fan	1000 W - 1ph / 1500 - 3ph					2000 W - 1ph / 3000 W - 3ph			3500 W - 3ph
Condenser fan	900 W - 1ph					2000 W - 3ph			2000 W + 2000 W 3ph
Light	800 W								
Other outputs	AUX configurable; solenoid valve output; compressor crankcase heater; power supply Kriwan								
<b>Other specifications</b>									
Connectivity (serial) RS485	Optional (with IROPZSER30 card)								

### Functional diagram

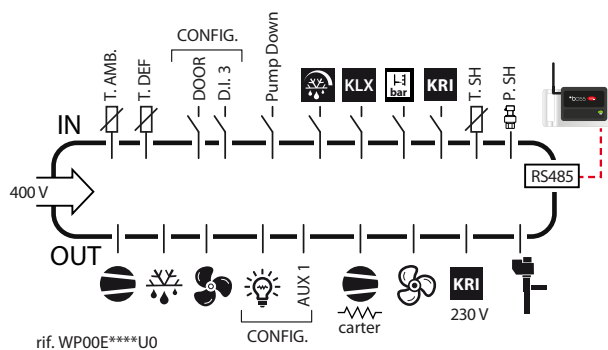

### Product part number

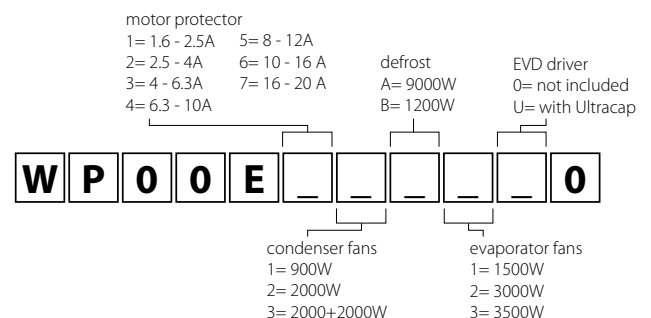

# Driver modules



without display



with display

Control module for bipolar electronic valve, IP65, available in modular or stand-alone version, with and without connectable display. Optional Ultracap technology. Advanced two-way communication via RS485 (UltraCella) or one-way via control signal (SmartCella, MasterCella). Configurable auxiliary relay.

## Accessories

EVDIS00IT0: display for EVD evolution in Italian. Also available in **EN**-English, **FR**-French, **DE**-German, **ES**-Spanish, **RU**-Russian, **SE**-Swedish, **CN**-Chinese and **CZ**-Czech.



## Plus



EEV control



Ultracap technology



configurable by UltraCella

Specifications	WM00ENS100	WM00ENS000	WM00ENN100	WM00EUS000	WM00EUN000	WM00EUC000	WM00EUK000
Main	with display included (Italian/English)	connectable display (not included)	"closed" module	connectable display (not included), with Ultracap	"closed" module, with Ultracap	connectable display (not included) with Ultracap, stand-alone	"closed" module, with Ultracap, stand-alone
Compatibility	SmartCella, UltraCella	SmartCella, UltraCella	UltraCella	SmartCella, UltraCella	UltraCella	SmartCella, MasterCella, UltraCella	UltraCella
Dimensions	128x290x110 mm						
Ingress protection	IP65						
Power supply	230 Vac						
Ultracap (safety power supply)	-			YES			
<b>Inputs</b>							
Total	6						
Analogue (type)	4 (0-5 V; 4-20 mA; NTC; 0-10 V)						
Digital (type)	2						
<b>Outputs</b>							
Electronic valve	Bipolar						
Auxiliary relay	5(2) A @250 V						
<b>Other specifications</b>							
Connectivity (serial) RS485	YES						
Stand-alone installation (no side knock-outs)	-					YES	

## Functional diagram

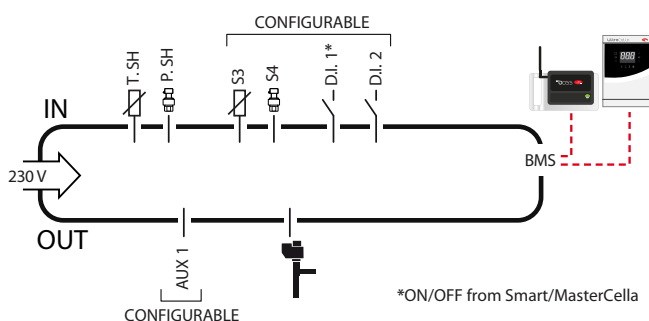

## Product part number

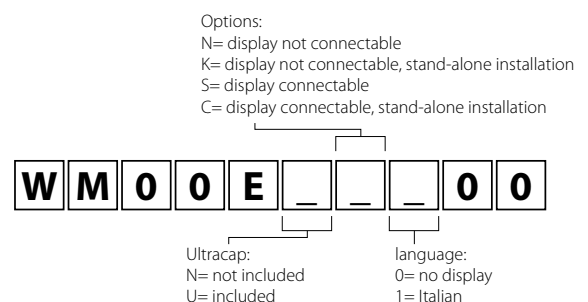

# Electronic expansion valve



Complete range of bipolar electronic stepper valves for HFC, HFO, subcritical CO<sub>2</sub> (E<sup>2</sup>V-Z and E<sup>3</sup>V-S max 60 barg) and transcritical CO<sub>2</sub> (E<sup>2</sup>V-C and E<sup>3</sup>V-CW max 140 barg). E<sup>2</sup>V-Z, E<sup>3</sup>V-S and E<sup>3</sup>V-CW versions with “smart” technology, which can be disassembled and inspected, with built-in removable filter, E<sup>2</sup>V-C version with weld technology.

## Accessories

E2VCABS\*10: shielded cable for E<sup>2</sup>V-Z with superseal connector (\* = 3, 6 and 9 m long).

E2VCABS\*00: shielded cable for E<sup>3</sup>V-S, E<sup>2</sup>V-C, E<sup>3</sup>V-CW (\* = 3, 6 and 9 m long).

## Plus



energy saving



food preservation



fast pull-down



performance

## E<sup>2</sup>V-Z

Specifications (mm)	E2V03ZSF03	E2V03ZSF13	E2V05ZSF03	E2V05ZSF13	E2V09ZSF03	E2V09ZSF13	E2V11ZSF03	E2V11ZSF13	E2V14ZSF03	E2V14ZSF13	E2V18ZSF03	E2V18ZSF13	E2V24ZSF03	E2V24ZSF13	E2V24ZSM03	E2V24ZSM13	E2V30ZSM03	E2V30ZSM13	E2V35ZSM03	E2V35ZSM13
Stator type	Bipolar, with IP67 superseal connector																			
Fittings (in/out)	12 - 12 mm ODF														16 mm (5/8" - 5/8" ODF)					
Size (mm)	03		05		09		11		14		18		24		24		30		35	
Indicator light	YES	-	YES	-	YES	-	YES	-	YES	-	YES	-	YES	-	YES	-	YES	-	YES	-

Specifications (mm)	E2V03ZWF03	E2V03ZWF13	E2V05ZWF03	E2V05ZWF13	E2V09ZWF03	E2V09ZWF13	E2V11ZWF03	E2V11ZWF13	E2V14ZWF03	E2V14ZWF13	E2V18ZWF03	E2V18ZWF13	E2V24ZWF03	E2V24ZWF13
Stator type	Bipolar, with IP67 superseal connector													
Fittings (in/out)	1/2" - 1/2" ODF													
Size (mm)	03		05		09		11		14		18		24	
Indicator light	YES	-	YES	-	YES	-	YES	-	YES	-	YES	-	YES	-

## E<sup>3</sup>V-S

Specifications (mm/inch)	E3V45SSR00	E3V45SSR10	E3V55SSR00	E3V55SSR10	E3V55SSS00	E3V55SSS10	E3V65SSS00	E3V65SSS10	E3V45SWR00	E3V45SWR10	E3V55SWR00	E3V55SWR10	E3V65SW500	E3V65SW510
Stator type	Bipolar								Bipolar					
Fittings (in/out)	18 - 22 mm				22 - 28 mm				3/4" - 7/8"				7/8" - 1" + 1/8"	
Size (mm)	45		55		65		45		55		65			
Indicator light	YES	-	YES	-	YES	-	YES	-	YES	-	YES	-	YES	-

## E<sup>2</sup>V-C for transcritical CO<sub>2</sub>

Specifications (mm)	E2V03CS100	E2V05CS100	E2V09CS100	E2V11CS100	E2V14CS100	E2V18CS100	E2V24CS100
Stator type	Bipolar						
Fittings (in/out)	13 - 13 mm ID (18 - 18 mm OD)						
Size (mm)	03	05	09	11	14	18	24
Indicator light	-						

## E<sup>3</sup>V-CW for transcritical CO<sub>2</sub>

Specifications (mm/inch)	E3V30CWM00	E3V35CWM00	E3V45CWM00	E3V55CWR00	E3V65CWR00
Stator type	Bipolar				
Fittings (in/out)	16 mm (5/8" - 5/8" ODF)			22 mm ID (7/8" - 7/8" ODF)	
Size (mm)	03	05	09	11	14
Indicator light	-				



## Valve sizing table

Maximum cooling capacity (kW) based on evaporation temperature (°C)	Valve type											
	E2V									E3V		
	03	05	09	11	14	18	24	30	35	45	55	65
<b>R404A</b>												
0 °C	1,04	1,47	2,45	4,30	6,80	9,20	18,50	27,70	37,50	66,00	97,00	130,00
-10 °C	1,05	1,48	2,48	4,34	6,80	9,30	18,60	28,00	37,90	66,00	98,00	131,00
-30 °C	1,00	1,42	2,37	4,15	6,50	8,90	17,80	26,60	36,20	64,00	94,00	125,00
<b>R410A</b>												
7 °C	1,65	2,35	3,95	6,90	10,90	14,80	29,8	44,5	60,5	106,0	175,0	210,00
0 °C	1,78	2,50	4,15	7,30	11,50	15,70	31,0	46,5	63,5	112,0	165,0	220,00
-10 °C	1,80	2,60	4,35	7,60	11,90	16,30	32,5	48,5	66,0	115,0	172,0	229,00
<b>R407C</b>												
7 °C	1,47	2,10	3,50	6,10	9,60	13,00	26,00	39,00	53,00	93,00	137,00	183,00
0 °C	1,53	2,15	3,60	6,30	9,90	13,50	27,00	40,50	55,00	96,00	142,00	191,00
-10 °C	1,57	2,22	3,70	6,50	10,20	13,90	27,50	41,50	56,00	99,00	146,00	195,00
<b>R407F</b>												
0 °C	1,63	2,30	3,80	6,70	10,50	14,30	28,50	43,20	58,50	103,00	152,00	202,00
-10 °C	1,67	2,34	3,94	6,85	10,80	14,80	29,50	44,40	60,40	105,00	155,00	207,00
-30 °C	1,68	2,35	3,95	6,86	10,90	14,80	29,60	44,50	60,40	105,00	156,00	208,00
<b>R134a</b>												
7 °C	1,11	1,58	2,64	4,55	7,20	9,80	19,80	29,50	40,30	70,00	104,00	139,00
0 °C	1,14	1,60	2,66	4,65	7,40	10,10	20,10	30,30	41,00	72,00	106,00	142,00
-10 °C	1,12	1,61	2,63	4,60	7,20	10,10	19,60	29,30	40,00	71,00	104,00	139,00
<b>R448A</b>												
0 °C	1,46	2,05	3,45	6,02	9,50	12,90	25,90	38,70	52,50	92,00	136,00	182,00
-10 °C	1,49	2,12	3,52	6,15	9,70	13,30	26,50	39,50	53,80	95,00	140,00	186,00
-30 °C	1,47	2,10	3,50	6,10	9,60	13,10	26,20	39,20	53,20	94,00	138,00	184,00
<b>R449A</b>												
0 °C	1,43	2,02	3,38	5,90	9,30	12,70	25,30	38,00	51,50	90,00	133,00	178,00
-10 °C	1,46	2,07	3,45	6,05	9,50	13,00	25,90	38,90	52,50	92,00	137,00	182,00
-30 °C	1,45	2,05	3,40	5,95	9,40	12,80	25,60	38,30	52,00	91,00	135,00	180,00
<b>R452A</b>												
7 °C	1,10	1,56	2,61	4,56	7,20	9,80	19,50	29,30	39,60	70,00	103,00	138,00
0 °C	1,11	1,58	2,62	4,60	7,20	9,90	19,80	29,60	40,10	70,00	104,00	139,00
-10 °C	1,06	1,51	2,51	4,40	6,90	9,40	18,90	28,30	38,40	67,00	99,00	133,00
<b>R513A</b>												
7 °C	0,90	1,28	2,13	3,71	5,80	8,00	16,00	23,80	32,50	57,00	84,00	112,00
0 °C	0,93	1,31	2,20	3,83	6,00	8,20	16,50	24,80	33,50	58,00	87,00	115,00
-10 °C	0,94	1,32	2,22	3,85	6,10	8,30	16,60	25,00	33,70	59,00	88,00	117,00
<b>R1234ze</b>												
0 °C	0,81	1,15	1,91	3,35	5,30	7,10	14,30	21,50	29,20	51,00	76,00	101,00
-10 °C	0,83	1,19	1,98	3,47	5,40	7,40	14,80	22,30	30,20	53,00	78,00	105,00
-30 °C	0,85	1,20	2,00	3,51	5,50	7,50	15,00	22,50	30,60	54,00	79,00	106,00

Condensing temperature = 45°C, subcooling = 4°C. (The maximum cooling capacity refers to the valve when fully open)

## Valve sizing table for CO<sub>2</sub>

Maximum cooling capacity (kW) based on evaporation temperature (°C)	Valve type													
	E2V-C									E3V				
	03	05	09	11	14	18	24	30	35	30	35	45	55	65
<b>R774</b>														
0 °C	1,30	1,90	3,10	5,50	8,70	11,80	23,70	35,60	48,20	49,90	61,00	83,20	111,00	143,50
-10 °C	2,10	2,90	4,90	8,70	13,70	18,60	37,30	56,00	75,70	77,90	95,90	130,80	174,40	225,40
-30 °C	2,80	4,00	6,70	11,80	18,60	25,40	50,80	76,30	105,30	106,80	130,60	178,10	237,40	290,00

Receiver pressure = 40 bars, subcooling = 0 ° K. (The maximum cooling capacity refers to the valve when fully open)

# 1 ph protection modules and direct 3 ph power modules



Protection and power modules, IP65, available in the version for modular connection to the cold room panel. Single-phase version with protection via residual-current circuit breaker and management of loads up to 3HP. Three-phase version with four-pole circuit breaker and management of defrosts up to 11 kW and evaporator fans up to 4 kW.

Plus



direct management



electromechanical protection

Specifications	WM00P000NN	WM00P0003N	WT00SD00NO	WT00CBF0NO	WT00CCG0NO	WT00CDG0NO	
Main	1ph residual-current circuit breaker	1ph residual-current circuit breaker and 3 HP contact relay	3ph defrost	3ph defrost and 1/3ph evaporator fans			
Compatibility	SmartCella, UltraCella						
Dimensions	128x290x110 mm						
Front ingress protection	IP65						
Power supply	230 Vac		400 Vac				
Main protection (circuit breaker)	20 A @ 230 Vac		16 A @ 400 Vac	6 A @ 400 Vac	10 A @ 400 Vac	16 A @ 400 Vac	
Panel protection (fuse)	-			6 A @ 230 Vac			
<b>Inputs</b>							
Other inputs provided (contact)	-			Evaporator fan thermal protection, safety thermostat (defrost)			
<b>Outputs</b>							
1ph support relay	-	3HP (30A res.)	-	-	-	-	
400 V defrost	-	-	11000 W - 3ph	4000 W - 3ph	7000 W - 3ph	11000 W - 3ph	
400 V/230 V evaporator fans	-	-	-	3000 W - 3ph / 1100 W - 1ph	4000 W - 3ph / 1700 W - 1ph	4000 W - 3ph / 2200 W - 1ph	

## Functional diagram

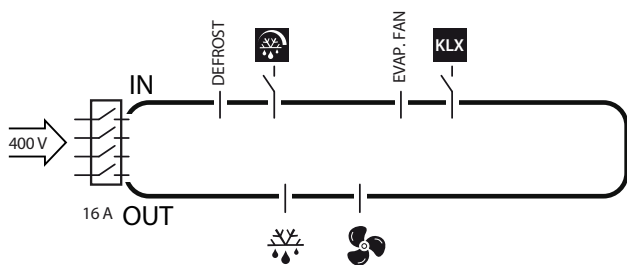

ref. WT00CDG0NO

## Product part number

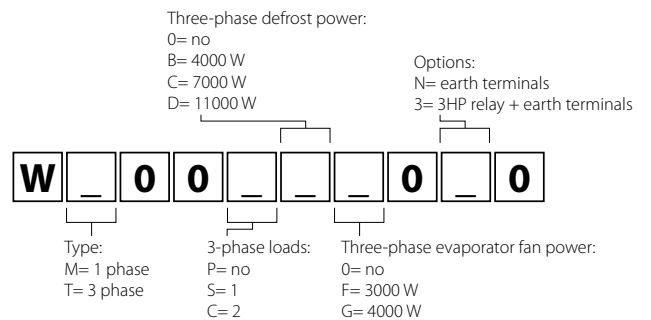

# Remote 3ph power modules



Protection and power modules, IP55, for remote serial connection to UltraCella. Version for management of three-phase evaporator only with defrost up to 20 kW or version for complete management of three-phase cold room with compressor up to 20 A.

## Plus



electromechanical protection



configurable by UltraCella

Specifications	WT00E600N0	WT00E900N0	WT00EA00N0	WT00F4B0N0	WT00F7C0N0
Main	Evaporator module 6 kW	Evaporator module 9 kW	Evaporator module 20 kW	Full module 4 HP	Full module 7.5 HP
Dimensions	452x380x186 mm				
Ingress protection	IP55				
Power supply	400 Vac				
<b>Protection functions</b>					
Compressor (manual motor starter)	-			10 to 16 A	16 to 20 A
Evaporator, condenser, defrost (circuit breaker)	16 A	25 A	40 A	16 A	25 A
<b>Inputs</b>					
Defrost/auxiliary defrost probe (type)	2 (NTC)				
Condenser probe (type)	-			1 (NTC)	
Condenser fan speed control	-			YES	
Evaporator safety devices (contact)	Safety thermostat (defrost), thermal protection (evaporator fans)				
Other inputs provided (contact)	-			Compressor Kriwan, high/low pressure switch, pump down	
<b>Outputs</b>					
Compressor	-			10 to 16 A	16 to 20 A
Defrost	6000 W - 3ph	9000 W - 3ph	20000 W - 3ph	6000 W - 3ph	9000 W - 3ph
Evaporator fan	550 W - 3ph / 0 to 10 Vdc	2000 W - 3ph / 0 to 10 Vdc	4000 W - 3ph / 0 to 10 Vdc	550 W - 3ph / 0 to 10 Vdc	2000 W - 3ph / 0 to 10 Vdc
Condenser fan 1/2	-			800 W - 1ph	
Other outputs	AUX configurable, solenoid valve				
	-			compressor crankcase heater, power supply Kriwan	
<b>Other specifications</b>					
Connectivity (serial) RS485	YES				

## Functional diagram

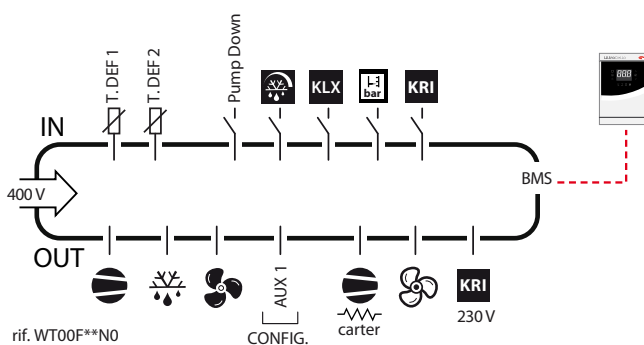

## Product part number

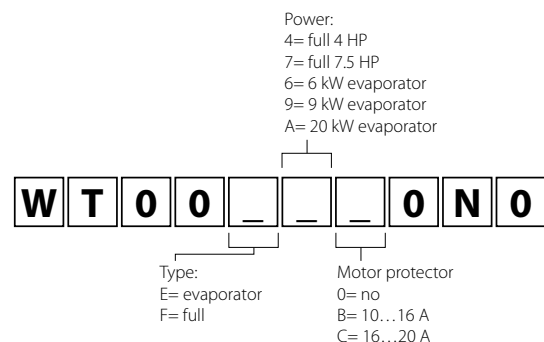

# Connectivity

## boss mini



System for monitoring, management and optimisation of small-medium installations. Full compatibility with mobile devices and built-in WiFi allow direct and simple access to the system, including during installation and configuration. Plug-ins are available

that enable advanced features (for information, contact your local dealer)

### Accessories

BMESTPWA00: 230 Vac power supply.

Specifications	BMEST00LE0	BMEST00RE0	BMEST00RS0
Version	advanced	basic	basic
Number of devices/variables logged	50/500	50/500	30/300
Dimensions	143x100x30 mm		
Power supply	24 Vdc (optional 230 Vac power supply)		
<b>Hardware</b>			
Built-in Wi-Fi connectivity to mobile devices	YES	NO	NO
Video output	YES: micro HDMI	NO	NO
Double Ethernet port (separation of LAN/Internet connections)	YES		
Built-in backup memory expansion	YES with SD card		
Embedded RS485 ports	1 opto-isolated 1 not opto-isolated		
Built-in digital outputs	3 outputs powered at +24Vdc		
USB host ports	1		
Status LED	2 front (ON/OFF, alarm)		
Possibility to connect an external UMTS modem to send SMS messages	YES		
<b>Software</b>			
Web connection with encrypted protocol (HTTPS)	YES		
Third-party device integration	YES (using device creator tool)		
Minimum variable sampling time	30 sec		
Other specifications	Modbus RTU master prot; Modbus TCP/IP master prot; send emails, send instant messages (Telegram), send SMS; manual and/or automatic reports as CSV and PDF; scheduled activity management		

## I-O Logger



10 or 20 channel logging system for monitoring and recording at regular intervals temperature, pressure and humidity values, digital inputs and alarms. All of the information can be viewed on the built-in touch display and exported via USB key, printed and sent by email.

The devices in the installation can be integrated via an RS485 serial connection.

Specifications	PW3C000TP100	PW3C000TP200
Number of input channels	10	20
Built-in digital outputs	2	
Number of devices/variables logged	15/300	
Dimensions	380x300x120 mm	
Front ingress protection	IP56	
Power supply	230 Vac max 50W	
Main display	LCD TFT, 800x480 (WVGA), resistive touch, 64k colours	
Connectivity	2 LAN ports (internal switch); 2 embedded RS485 ports	
Storage	1 USB and 1 SD card slot	
Configurable variable sampling time	30 sec, 1 min, 3 min, 5 min, 15 min (default=15min)	
Data log capacity	1 year with sampling frequency = 15 minutes	
Other specifications	Send emails, sending SMS; manual and/or automatic reports in CSV format	

# Accessories

## Centrifugal humidifier - humiDisk



Compact centrifugal humidifier, with atomisation by spinning disk. It operates with both mains and demineralised

water, automatic emptying of the tank after each operating cycle.

Specifications	UC0100DK00	UC0650D000	UC0650D100
main	humiDisk10; capacity: 1 kg/h	humiDisk65; capacity: 6.5 kg/h	humiDisk65; capacity: 6.5 kg/h
Dimensions	312x302x390 mm	565x505x610mm	
Power supply	230 Vac max 50 W		
Operating conditions	1 to 35 °C		-2 to 35 °C
Other specifications	pipng + wall bracket kit	-	frost protection heater

## ColdWatch



Trapped personnel alarm kit, safety device for low temperature cold rooms, compliant with EN 378-1. Kit comprising an external control unit with siren, flashing light, backup battery

and emergency button (mushroom-head with light). On request, versions are available for Denmark, Australia, Portugal, Sweden, Poland, the Netherlands.

Specifications	CM00006079	CM00005953	CM00006080	CM00006081	CM00006056	CM00006237	CM00006433
Main (language)	Italian	English	Spanish	German	French	Portuguese	Swedish
Dimensions	external control unit: 200x240x88mm; button: 64x70x73mm						
Power supply	mains: 230 Vac; backup battery: 12 Vdc 2 Ah						
Operating conditions	external control unit: -10 to 40°C, button: -25 to 40 °C						
Ingress protection	external control unit: IP54, button: IP65						
Auxiliary relay	5 A 250 Vac - NC or NO logic, selectable						

## Refrigerant gas leakage detector



Refrigerant gas leak detectors with built-in or remote sensor. Integration with CAREL or third-party controllers via analogue, digital or RS485 serial communication. On request, version

available with complete 230 Vac panel with flashing light and siren.

Specifications	GDW*S02A00	GDW*S04A00	GDW*S06A00	GDW*S08A00	GDW*S09A00	GDW*S11A00	GDW*S18A00	GDW*S120A00
Refrigerant	R134a	R404A	R407F	R448A	R449A	R452A	R513A	R744
Dimensions	built-in: 165x165x87 mm - remote: 115x136x68 mm							
Power supply	24 Vac / 19.5-28.5 Vdc							
Operating conditions	from -40°C to 50°C							
Ingress protection	IP66							
Outputs	1 analogue output: 4-20 mA, 0-5 V, 0-10 V, 1-5 V, 2-10 V - 3 digital outputs							
Communication	Bluetooth - RS485 Modbus serial							

\* : B = built-in sensor, R = remote sensor

## Sensors



Range of sensors and transducers for measuring temperature, temperature/humidity and pressure. Suitable for installation inside the cold room and/or on the evaporator.

		Description	Operating conditions	Cable length (m)
<b>Active sensors - temperature and humidity</b>				
T AMB		DPCC112000	Power supply: 18/32 Vdc - 12/24 Vac Output: 0 to 10 Vdc	Temperature (-10 to 60°C) and humidity (10 to 90% RH)
		DPCC212000	Power supply: 18/32 Vdc - 12/24 Vac Output: 0 to 10 Vdc	Temperature (-20 to 70 °C) and humidity (0 to 100 % RH)
H AMB		DPCC110000	Power supply: 8/32 Vdc - 12/24 Vac Configurable output: -0.5 to 1 Vdc or 4 to 20 mA	Temperature (-10 to 60°C) and humidity (10 to 90% RH)
		DPCC210000	Power supply: 8/32 Vdc - 12/24 Vac Configurable output: -0.5 to 1 Vdc or 4 to 20 mA	Temperature (-20 to 70 °C) and humidity (0 to 100% RH)
<b>Temperature sensors</b>				
T AMB		NTC030HF03	NTC HF probe (strap-on)	-50 to 90 °C
		NTC060HF03	NTC HF probe (strap-on)	-50 to 90 °C
		NTC015HP03	NTC HP probe	-50 to 105 °C
		NTC030WH03	NTC WH probe	-50 to 105 °C
		NTC060WH03	NTC WH probe	-50 to 105 °C
<b>Ratiometric pressure transducers</b>				
P SH		SPKT0053P0	0 to 5 V ratiometric	-1 to 4.2 bars
		SPKT0013P0	0 to 5 V ratiometric	-1 to 9.3 bars
		SPKT00E3P0	0 to 5 V ratiometric	-1 to 12.8 bars
		SPKT0043P0	0 to 5 V ratiometric	0 to 17.3 bars
		SPKT00F3P0	0 to 5 V ratiometric	0 to 20.7 bars
		SPKT0033P0	0 to 5 V ratiometric	0 to 34.5 bars
		SPKT00B6P0	0 to 5 V ratiometric	0 to 45 bars
		SPKT00G1S0	0 to 5 V ratiometric	0 to 60 bars
		SPKT00L1S0	0 to 5 V ratiometric	0 to 90 bars
<b>4 - 20 mA pressure transducers</b>				
P SH		SPKT0021C3	4 to 20 mA	-0.5 to 7 bars
		SPKT0011C3	4 to 20 mA	0 to 10 bars
		SPKT0041C0	4 to 20 mA	0 to 18.2 bars
		SPKT0031C3	4 to 20 mA	0 to 30 bars
		SPKT00B1C3	4 to 20 mA	0 to 44.8 bars
		SPKT00G1C0	4 to 20mA	0 to 60 bars
<b>Pressure sensor cables</b>				
	SPKC002313	Cable with IP67 connector	-20 to 105 °C	2
	SPKC005313	Cable with IP67 connector	-20 to 105 °C	5
	SPKC00A310	Cable with IP67 connector	-20 to 105 °C	12

# Information and support

In addition to the corporate website [www.carel.com](http://www.carel.com) and the Customer Service department, available at [cst@carel.com](mailto:cst@carel.com), CAREL provides a series of before- and after-sales support services on its products and solutions.

## Tools



### Electronic valve sizing tool

Available for air-conditioning and refrigeration applications, including for CO<sub>2</sub> systems.

<https://exvselectiontool.carel.com/ExVLab/index.jsp>



### Knowledge sharing area

- Before- and after-sales training and support material;
- software for updating products and supervision systems;
- document repository: certification and declarations.

<https://ksa.carel.com>



## Apps



### Quick Finder

the selection tool for refrigeration applications, designed and developed for distributors and installers.

Available for Android and IOS

<https://www.carel.com/apps>



## Video

The official CAREL YouTube channel features videos presenting the CAREL product solutions, tutorials for correct installation and configuration, interviews during exhibitions and events and much more.



CAREL UltraCella installation



CAREL E<sup>2</sup>V-Z tutorial



CAREL boss tutorial



## Headquarters ITALY

### CAREL INDUSTRIES HQs

Via dell'Industria, 11  
35020 Brugine - Padova (Italy)  
Tel. (+39) 0499 716611  
Fax (+39) 0499 716600  
carel@carel.com



## For more information

CAREL Poland  
ALFACO POLSKA  
[www.carel.pl](http://www.carel.pl)

CAREL Asia  
[www.carel.hk](http://www.carel.hk)

CAREL Australia  
[www.carel.com.au](http://www.carel.com.au)

CAREL Central & Southern Europe  
[www.carel.com](http://www.carel.com)

CAREL Czech & Slovakia  
CAREL spol. s.r.o.  
[www.carel.cz](http://www.carel.cz)

CAREL Deutschland  
[www.carel.de](http://www.carel.de)

CAREL China  
[www.carel-china.com](http://www.carel-china.com)

CAREL France  
[www.carelfrence.fr](http://www.carelfrence.fr)

CAREL Korea  
[www.carel.kr](http://www.carel.kr)

CAREL Ibérica  
[www.carel.es](http://www.carel.es)

CAREL Ireland  
FarrahVale Controls & Electronics Ltd.  
[www.carel.ie](http://www.carel.ie)

CAREL Italy  
[www.carel.it](http://www.carel.it)

CAREL India  
[www.carel.in](http://www.carel.in)

CAREL Japan  
[www.carel-japan.com](http://www.carel-japan.com)

CAREL Mexicana  
[www.carel.mx](http://www.carel.mx)

CAREL Middle East  
[www.carel.ae](http://www.carel.ae)

CAREL Nordic  
[www.carelnordic.se](http://www.carelnordic.se)

CAREL Russia  
[www.carelrussia.com](http://www.carelrussia.com)

CAREL South Africa  
[www.carelcontrols.co.za](http://www.carelcontrols.co.za)

CAREL Sud America  
[www.carel.com.br](http://www.carel.com.br)

CAREL Thailand  
[www.carel.co.th](http://www.carel.co.th)

CAREL Turkey  
CFM Sogutma ve Otomasyon San. Tic. Ltd.  
[www.carel.com.tr](http://www.carel.com.tr)

CAREL U.K.  
[www.careluuk.com](http://www.careluuk.com)

CAREL U.S.A.  
[www.carelusa.com](http://www.carelusa.com)

# CAREL

To the best of CAREL INDUSTRIES S.p.A. knowledge and belief, the information contained herein is accurate and reliable as of the date of publication. However, CAREL INDUSTRIES S.p.A. does not assume any liability whatsoever for the accuracy and completeness of the information presented without guarantee or responsibility of any kind and makes no representation or warranty, either expressed or implied. A number of factors may affect the performance of any products used in conjunction with user's materials all of which must be taken into account by the user in producing or using the products. The user should not assume that all necessary data for the proper evaluation of these products are contained herein and is responsible for the appropriate, safe and legal use, processing and handling of CAREL's products. The Information provided herein does not relieve the user from the responsibility of carrying out its own tests, and the user assumes all risks and liabilities related to the use of the products and/or information contained herein. © 2018 CAREL INDUSTRIES S.p.A. All rights reserved.