

EVD ice

Superheat control for unipolar electronic expansion valve

CAREL



ENG User manual

**LEGGI E CONSERVA
QUESTE ISTRUZIONI!**
**READ AND SAVE
THESE INSTRUCTIONS**

**NO POWER
& SIGNAL
CABLES
TOGETHER**
READ CAREFULLY IN THE TEXT!

High Efficiency Solutions

WARNINGS



CAREL bases the development of its products on decades of experience in HVAC, on the continuous investments in technological innovations to products, procedures and strict quality processes with in-circuit and functional testing on 100% of its products, and on the most innovative production technology available on the market. CAREL and its subsidiaries nonetheless cannot guarantee that all the aspects of the product and the software included with the product respond to the requirements of the final application, despite the product being developed according to start-of-the-art techniques. The customer (manufacturer, developer or installer of the final equipment) accepts all liability and risk relating to the configuration of the product in order to reach the expected results in relation to the specific final installation and/or equipment. CAREL may, based on specific agreements, acts as a consultant for the positive commissioning of the final unit/application, however in no case does it accept liability for the correct operation of the final equipment/system.

The CAREL product is a state-of-the-art product, whose operation is specified in the technical documentation supplied with the product or can be downloaded, even prior to purchase, from the website www.carel.com. Each CAREL product, in relation to its advanced level of technology, requires setup/configuration/programming/commissioning to be able to operate in the best possible way for the specific application. The failure to complete such operations, which are required/indicated in the user manual, may cause the final product to malfunction; CAREL accepts no liability in such cases. Only qualified personnel may install or carry out technical service on the product. The customer must only use the product in the manner described in the documentation relating to the product.

In addition to observing any further warnings described in this manual, the following warnings must be heeded for all CAREL products:

- prevent the electronic circuits from getting wet. Rain, humidity and all types of liquids or condensate contain corrosive minerals that may damage the electronic circuits. In any case, the product should be used or stored in environments that comply with the temperature and humidity limits specified in the manual;
- do not install the device in particularly hot environments. Too high temperatures may reduce the life of electronic devices, damage them and deform or melt the plastic parts. In any case, the product should be used or stored in environments that comply with the temperature and humidity limits specified in the manual;
- do not attempt to open the device in any way other than described in the manual;
- do not drop, hit or shake the device, as the internal circuits and mechanisms may be irreparably damaged;
- do not use corrosive chemicals, solvents or aggressive detergents to clean the device;
- do not use the product for applications other than those specified in the technical manual.

All of the above suggestions likewise apply to the controllers, serial boards, programming keys or any other accessory in the CAREL product portfolio. CAREL adopts a policy of continual development. Consequently, CAREL reserves the right to make changes and improvements to any product described in this document without prior warning. The technical specifications shown in the manual may be changed without prior warning.

The liability of CAREL in relation to its products is specified in the CAREL general contract conditions, available on the website www.carel.com and/or by specific agreements with customers; specifically, to the extent where allowed by applicable legislation, in no case will CAREL, its employees or subsidiaries be liable for any lost earnings or sales, losses of data and information, costs of replacement goods or services, damage to things or people, downtime or any direct, indirect, incidental, actual, punitive, exemplary, special or consequential damage of any kind whatsoever, whether contractual, extra-contractual or due to negligence, or any other liabilities deriving from the installation, use or impossibility to use the product, even if CAREL or its subsidiaries are warned of the possibility of such damage.

DISPOSAL



INFORMATION FOR USERS ON THE CORRECT HANDLING OF WASTE ELECTRICAL AND ELECTRONIC EQUIPMENT (WEEE)

In reference to European Union directive 2002/96/EC issued on 27 January 2003 and the related national legislation, please note that:

1. WEEE cannot be disposed of as municipal waste and such waste must be collected and disposed of separately;
2. the public or private waste collection systems defined by local legislation must be used. In addition, the equipment can be returned to the distributor at the end of its working life when buying new equipment;
3. the equipment may contain hazardous substances: the improper use or incorrect disposal of such may have negative effects on human health and on the environment;
4. the symbol (crossed-out wheeled bin) shown on the product or on the packaging and on the instruction sheet indicates that the equipment has been introduced onto the market after 13 August 2005 and that it must be disposed of separately;
5. in the event of illegal disposal of electrical and electronic waste, the penalties are specified by local waste disposal legislation.

Warranty on the materials: 2 years (from the date of production, excluding consumables).

Approval: the quality and safety of CAREL INDUSTRIES products are guaranteed by the ISO 9001 certified design and production system, as well as by the marks (*).

CAUTION: separate as much as possible the probe and digital input signal cables from the cables carrying inductive loads and power cables to avoid possible electromagnetic disturbance. Never run power cables (including the electrical panel wiring) and signal cables in the same conduits.



Content

1. INTRODUCTION	7
1.1 Models	7
1.2 Functions and main characteristics	7
1.3 Accessories	7
2. INSTALLATION	8
2.1 Dimensions - mm (in).....	8
2.2 Assembly on the evaporator	8
2.3 Application diagrams.....	9
2.4 Wiring description.....	10
2.5 Wiring.....	10
3. USER INTERFACE	11
3.1 Keypad.....	11
3.2 Display and visualisation	11
3.3 Programming mode.....	11
3.4 Restore default parameters (factory).....	11
4. COMMISSIONING	12
4.1 Commissioning procedure	12
4.2 Parameters first configuration	12
5. FUNCTIONS	13
5.1 Control.....	13
5.2 Service parameters	14
6. PROTECTORS	15
6.1 Protectors.....	15
7. PARAMETERS TABLE	17
8. NETWORK CONNECTION	19
8.1 RS485 serial configuration	19
8.2 Network connection for commissioning via PC.....	19
8.3 Visual parameter manager.....	19
8.4 Restore default parameters.....	20
8.5 Setup by direct copy.....	20
8.6 Setup using configuration file	21
8.7 Read the configuration file on the controller.....	21
8.8 Variables accessible via serial connection	22
8.9 Control states	23
8.10 Special control states.....	24
9. ALARMS	26
9.1 Types of alarms.....	26
9.2 Probe alarms.....	26
9.3 Control alarms.....	26
9.4 Valve emergency closing procedure.....	26
9.5 Network alarm.....	26
9.6 Alarm table	27
10. TROUBLESHOOTING	28
11. TECHNICAL SPECIFICATIONS	30

1. INTRODUCTION

EVD ice is an electronic superheat controller for Carel unipolar expansion valves. EVD ice has been specially designed to be installed near the valve, directly on the refrigerant circuit, simplifying installation and making electronic expansion valve technology available directly on board the unit.

The plastic cover material on EVD ice guarantees total protection, allowing the controller to operate in particularly difficult environmental conditions, such as low temperatures and high humidity (condensation). EVD ice can be installed directly on a unit cooler/evaporator inside a cold room.

The controller is already fitted with sensors, signal and power cables: to complete the system, simply select the most suitable valve body and pressure transducer for the required cooling capacity from the compatible Carel product range.

EVD ice controls refrigerant superheat and optimises refrigerant circuit efficiency. It allows considerable system flexibility, being compatible with various types of refrigerants, in applications with refrigerators and chiller/air-conditioners. It features low superheat protection (LowSH), high evaporation pressure (MOP) and low evaporation pressure (LOP) functions.

The device also has a user interface that displays the instant superheat value at all times, signals any alarms, and above all can be used to set the operating parameters.

When installing the controller, only three initial parameters are required to start controlling the valve in the system:

- type of refrigerant
- operating mode (cold room, showcase, etc.)
- superheat set point.

EVD ice can easily be accessed via an RS485 serial connection (Modbus protocol), for supervision of operating parameters and alarms in real time.

The serial connection can also be used to set the operating parameters over a remote connection; in this case, combination with other Carel controllers is recommended (supervisors and cold room controllers).

1.1 Models

P/N	Description
EVDM011R3*	EVD ice 115/230 V, E2V stator, display
EVDM011R1*	EVD ice 115/230 V, E2V stator, display, Ultracap module connector
EVDM011R4*	EVD ice 115/230 V, E3V stator, display
EVDM011R2*	EVD ice 115/230 V, E3V stator, display, Ultracap module connector

(*): 0/1=single/multiple package (10 pcs)

Tab. 1.a

1.2 Functions and main characteristics

In summary:

- superheat control with LowSH, MOP, LOP functions;
- compatibility with various types of refrigerants;
- guided setup procedures first, entering just three parameters on the user interface: refrigerant (Gas), type of control (Mode) and superheat set point (Superheat);
- activation/deactivation of control via digital input or remote control via serial connection;
- controller and valve power supply incorporated (230 V/115 V);
- RS485 serial communication incorporated (Modbus protocol);
- IP65/IP67;
- operating conditions: -30T40C° (-22T104°F);
- compatible with Carel E2V and E3V single-pole valves.

1.3 Accessories

Ratiometric pressure probe P/N SPKT0013P0 (-1 to 9.3 bars)

The ratiometric pressure probe specified as default for assembly is P/N SPKT0013P0, with an operating range from -1 to 9.3 barg. Alternatively, other probes can be installed, setting the corresponding parameter accordingly. See the "Functions" chapter.



Fig. 1.a

P/N	Type	Photo nr.
SPKT0053P0	-1...4.2 barg	1
SPKT0013P0	-1...9.3 barg	
SPKT0043P0	0...17.3 barg	
SPKT0033P0	0...34.5 barg	
SPKT00B6P0	0...45 barg	
SPKT00E3P0	-1...12.8 barg	2
SPKT00F3P0	0...20.7 barg	
SPKT00G1S0	0...60 barg	
SPKT00L1S0	0...90 barg	

Tab. 1.b

Unipolar valve body

The valve body, to be purchased separately, is assembled using the stator supplied with EVD ice. For the part numbers, see the CAREL product catalogue.



Fig. 1.b

Ultracap module (P/N EVDMU**R**)

The module guarantees temporary power to the driver in the event of power failures, for enough time to immediately close the connected electronic valve. It avoids the need to install a solenoid valve. The module is made using Ultracap storage capacitors, which ensure reliability in terms of much longer component life than a module made with lead batteries.



Fig. 1.c

2. INSTALLATION

2.1 Dimensions - mm (in)

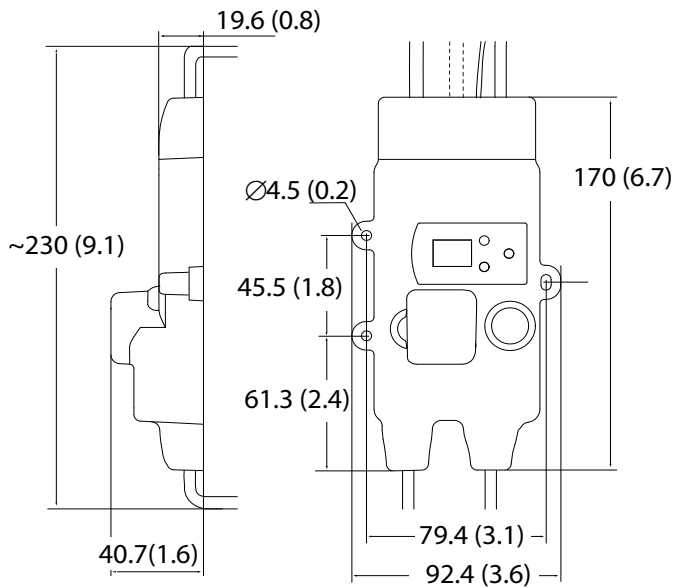

Fig. 2.a

Cable (*)	Length (±5%)
Power supply	500 (19.7)
RS485	500 (19.7)
Pressure probe	800 (31.5) --> E2V
	1800 (70.9) --> E3V
NTC probe	1800 (70.9)
E2V/ E3V valve	600 (23.6)
Ultracap	100 (3.9)

(*)= for standard CAREL part numbers

2.2 Assembly on the evaporator



Important:

- install EVD ice on the evaporator away from the places where ice forms;
- connect the power and serial cables in the IP65 junction box;
- for assembly of the E2V/ E3V valve, see the " ExV system" guide (+030220810).

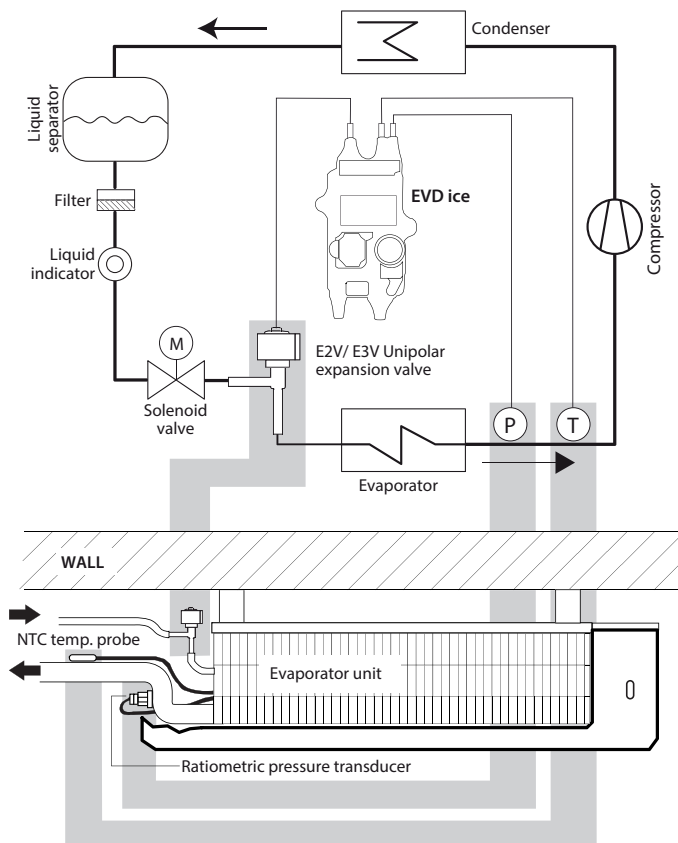

Fig. 2.d

EVD ice can be installed directly on the evaporator. Mark the position and drill the holes (Ø<4.5 mm). Then tighten the fastening screws.

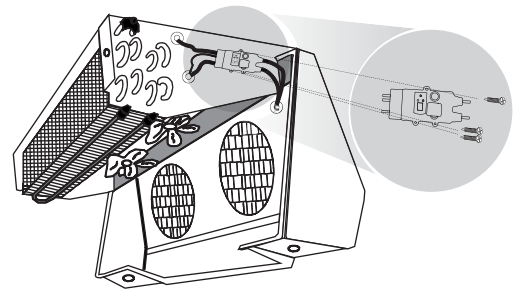

Fig. 2.e

2.3 Application diagrams

WITH SOLENOID VALVE

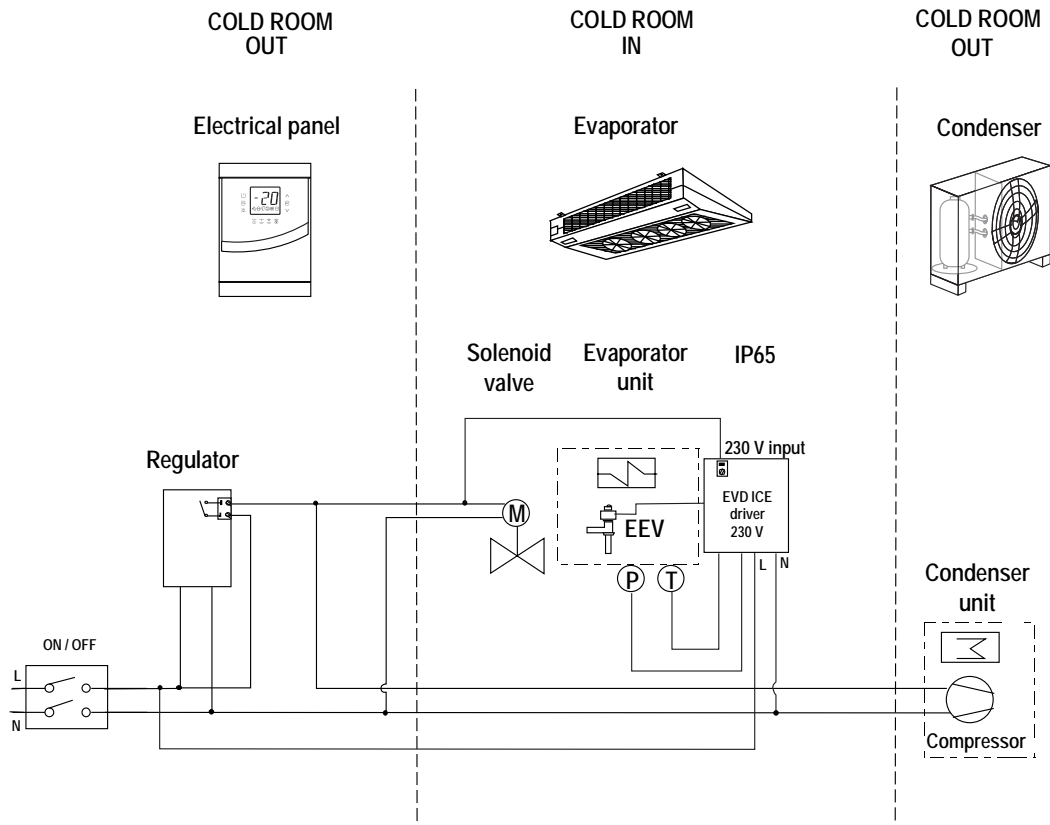

Fig. 2.f

WITHOUT SOLENOID VALVE, WITH ULTRACAP MODULE

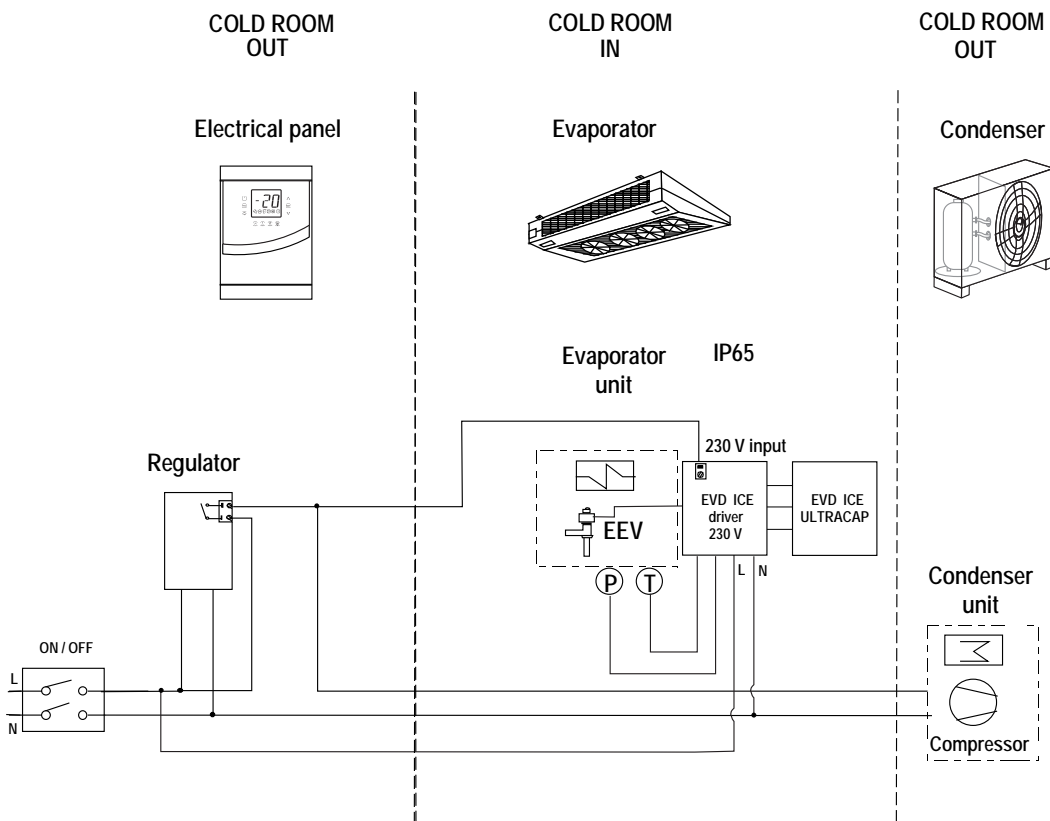

Fig. 2.g

2.4 Wiring description

The driver for superheat control requires the use of an evaporation pressure probe S1 and suction temperature probe S2, which will be fitted downstream of the evaporator, and a digital input to trigger control. Alternatively, the signal to trigger control can be sent via a remote serial connection.

Note: input S1 is programmable. See the “Functions” chapter

The following are already wired on EVD ice:

- pressure probe and temperature probe cables;
- electronic expansion valve stator;
- Ultracap module connection cable (on models where featured);
- power and serial line cables.

The power and serial line connections are identified by the colours of the wires.

Note: for probe installation see “Guide to EEV system”, (+03022811).

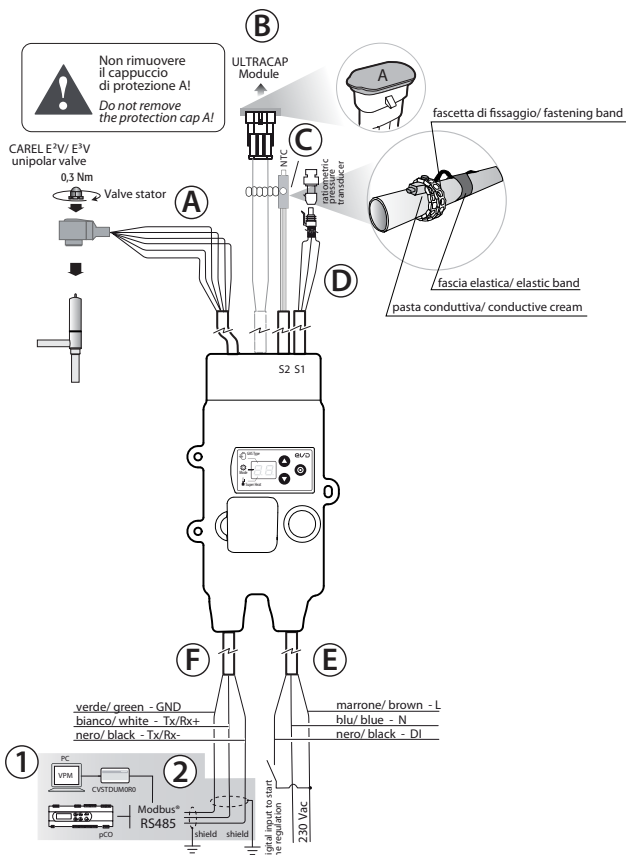

Fig. 2.b

Rif	Cable	Description
A	ExV	Unipolar electronic valve connection
B	Ultracap	Ultracap module connection (accessory)
C	Probe S2	NTC temperature probe
D	probe S1	Ratiometric pressure probe
E	Power supply	
	L: brown	Phase 230 V
	N: blue	Neutral 230 V
	DI: black	230 V digital input to enable control
F	Serial	
	Tx/ Rx +: white	RS485 connection
	Tx/ Rx -: black	
	GND: green	
1	-	Computer for configuration
2	-	USB- RS485 converter (for computer)

Tab. 2.a

2.5 Wiring

For installation, proceed as shown below, with reference to the wiring diagrams and the technical specifications table:

1. connect the pressure probe that suits the refrigerant. For details on refrigerant --> suggested pressure probe, see the chapter on “Commissioning”;
2. connect the power cable and the digital input cable: for the maximum length, see the technical specifications;
3. power on the driver: the display will light up, and the driver will await the commissioning parameters. See the chapter on “Commissioning”;
4. program the driver, if necessary: see the “User interface” chapter.

Note: if connecting to a serial network, see the previous diagram for details on connecting the shield to earth.

Installation environment

Important: avoid installing the drivers in environments with the following characteristics:

- strong vibrations or knocks;
- exposure to aggressive and polluting atmospheres (e.g.: sulphur and ammonia fumes, saline mist, smoke) to avoid corrosion and/or oxidation;
- strong magnetic and/or radio frequency interference (therefore avoid installing the devices near transmitting antennae);
- exposure of the drivers to direct sunlight and to the elements in general.

Important: the following warnings must be observed when connecting the drivers:

- if the driver is used in a way that is not specified in this user manual, protection cannot be guaranteed;
- incorrect power connections may seriously damage the driver;
- separate as much as possible (at least 3 cm) the probe and digital input cables from cables to electrical loads, to avoid possible electromagnetic disturbance. Never run power cables (including the electrical panel cables) and probe signal cables in the same conduits;
- do not run probe signal cables in the immediate vicinity of power devices (contactors, circuit breakers, etc.). Reduce the path of probe cables as much as possible, and avoid spiral paths that enclose power devices;
- *EVD ice is a controller to be incorporated into the final equipment; it must not be wall-mounted;
- * DIN VDE 0100: protective separation must be guaranteed between the SELV circuits (Safety Extra Low Voltage) and the other circuits. The requirements of DIN VDE 0100 must be complied with. To prevent disruption of the protective separation (between the SELV circuits and the other circuits) ensure additional fastening near the terminations. This additional fastening must secure the insulation and not the wires.

3. USER INTERFACE

The user interface comprises the two-digit display and keypad with three buttons that, pressed alone or in combination, are used to perform all the configuration and programming operations on the driver.

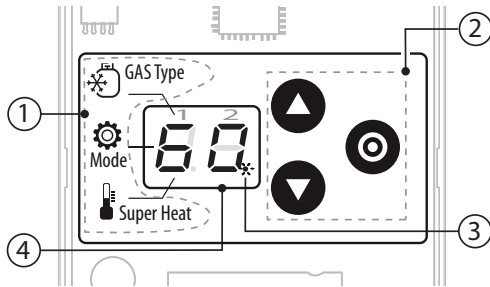

Fig. 3.a

Key	Description
1	Parameter label (for commissioning/setup)
2	Keypad
3	LED status digital input start/stop control blink/OFF = DI closed/open
4	Two-digit display

(*) when digital input is closed the LED blinks and control is active.

During commissioning/setup, the parameter label shows the meaning of the segments displayed in the first digit, corresponding to the three parameters being set:

- A. GAS Type: type of refrigerant;
- B. Mode: operating mode;
- C. Superheat: superheat set point.

See the "Commissioning" chapter.

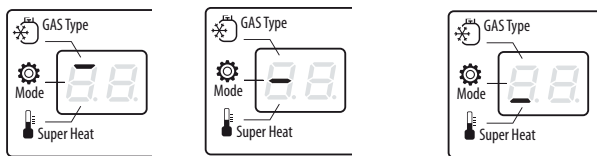

A. Refrigerant B. Mode (operating mode) C. Superheat set point

3.1 Keypad

Key	Description
▲ UP / ▼ DOWN	Increases/decreases the value of the set point or other selected parameter
⊙ PRG/Set	At the end of the commissioning procedure, if pressed for 2 s, exits the menu and control starts; Enter/ exit programming mode, saving the parameters; Reset E8 alarm.

Tab. 3.a

3.2 Display and visualisation

During normal operation, the two-digit display shows the superheat measure and any alarms.

The display interval for the superheat value is -5 to 55 K (-9 to 99 °F).

In general, values between -99 and 999 are displayed as follows:

1. values from 0 to 10 are displayed with decimal point and decimals;
2. values greater than 99 are displayed in two steps:
 - first, the hundreds, followed by "H"
 - then the tens and units.
3. values less than -9 are displayed in two steps:
 - first the "-" sign;
 - then the tens and units.

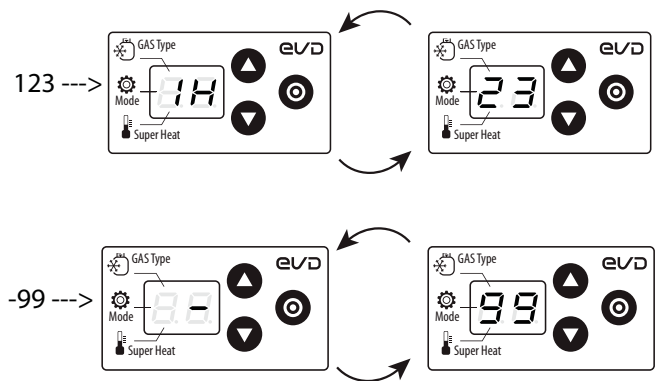

Fig. 3.b

Note: The decimal point in digit on the right, displays the start/stop control status. When the input is closed, point is ON Blinking.

3.3 Programming mode

The parameters can be modified using the front keypad.

Important: modify the control parameters, **ONLY AFTER** having completed the guided commissioning procedure, described in chapter 4.

Modifying the Service parameters

The Service parameters include, in addition to the parameters for the configuration of input S1, those corresponding to the network address, probe readings, protectors and manual positioning. See the parameter table.

Procedure:

1. press UP and DOWN together and hold for more than 5 s: the first parameter is displayed: P1 = probe S1 reading;
2. press UP/ DOWN until reaching the desired parameter;
3. press PRG/ Set to display the value;
4. press UP/ DOWN to modify the value;
5. press PRG/ Set to confirm and return to the parameter code;
6. repeat steps 2 to 5 to modify other parameters;
7. (when the parameter code is displayed) press PRG/ Set and hold for more than 2 s to exit the parameter setting procedure.

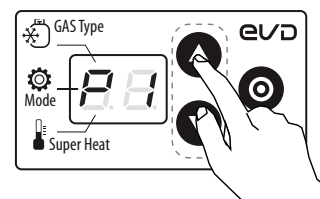

Fig. 3.c

Note: if no button is pressed, after around 30 s the display automatically returns to standard visualisation.

3.4 Restore default parameters (factory)

The driver can be reset to the default parameter values.

Procedure:

when the display is on standby, press all three buttons together. After 5 seconds, the display shows "rS". The reset procedure can be confirmed within 10 seconds, by pressing PRG/SET for 3 seconds. If no button is pressed during this time, the procedure will be cancelled. At the end the display shows two hyphens and then awaits the commissioning parameters.

4. COMMISSIONING

! Important: if the refrigerant is not available among the refrigerant parameter options, contact CAREL service to:

- confirm that the system (c.pCO/Ultracella,...)+EVDice+CARELelectronic expansion valve is compatible with the desired refrigerant (Gas type=custom);
- identify the values that define the custom refrigerant and enter them for parameters: "Dew a...f high/low". See the variables accessible via serial connection.

4.1 Commissioning procedure

Once the electrical connections have been completed (see the chapter "Installation") and the power supply has been connected, the operations required for commissioning the driver depend on the type of interface used, however essentially involve setting just 3 parameters: refrigerant, functioning mode, superheat setpoint.

! Important:

- until the commissioning procedure has been completed, control will not be active;
- (only during commissioning) changing the gas involves changing the value of the ratiometric probe parameter.

After powering up the driver, the display lights and the driver waits the control parameters, indicated by the hyphens. The default parameters are:

- Refrigerant = R404A;
- Type of control = multiplexed showcase/cold room
- Superheat set point = 11 K.

Procedure:

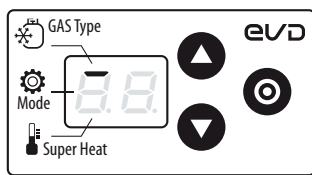

- The controller displays the bar at the top: refrigerant (GAS Type);

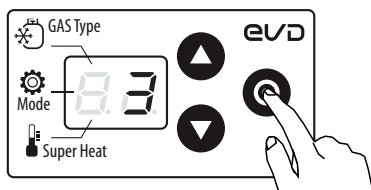

- Press PRG/Set: the refrigerant setting is shown = 3: R404A

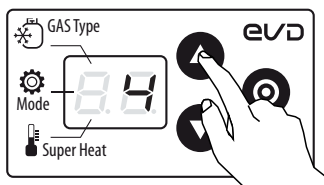

- Press UP/Down to change the value

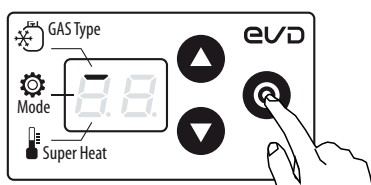

- Press PRG/Set to save and return to the refrigerant parameter code (bar at the top)

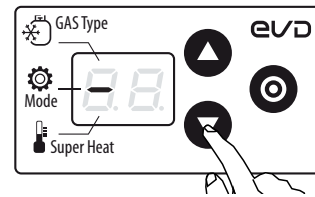

- Press Down to move to the next parameter: Mode, indicated by the bar in the middle;
- Repeat steps 2,3,4,5, to set the values of the other parameters: Mode, Superheat set point;

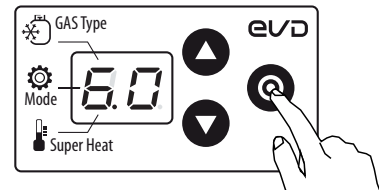

- Press PRG/Set for 2 seconds to exit the commissioning procedure and start control. The standard display is shown.

4.2 Parameters first configuration

! Important: ONLY DURING commissioning, changing the gas involves changing the value of the ratiometric probe parameter; if not specified in the table, the type of ratiometric probe is -1...9.3 barg.

Parameter/ description		Def.
Gas Type = refrigerant		3 = R404A
0	Custom	
1	R22	15 R422D 28 R1234ze(-1...4.2 barg)
2	R134a	16 R413A 29 R455A (-1...12.8 barg)
3	R404A	17 R422A 30 R170 (0...17.3 barg)
4	R407C	18 R423A 31 R442A (-1...12.8 barg)
5	R410A	19 R407A 32 R447A (-1...12.8 barg)
6	R507A	20 R427A 33 R448A
7	R290	21 R245FA 34 R449A
8	R600(-1...4.2 barg)	22 R407F 35 R450A (-1...4.2 barg)
9	R600a (-1...4.2 barg)	23 R32 (0...17.3 barg) 36 R452A (-1...12.8 barg)
10	R717	24 HTR01 37 R508B (-1...4.2 barg)
11	R744 (0...45 barg)	25 HTR02 38 R452B
12	R728	26 R23 39 R513A (-1...4.2 barg)
13	R1270	27 R1234yf 40 R454B
14	R417A	

Note: if the refrigerant is not available among the refrigerant options, "GAS Type=refrigerant":

- set any refrigerant (for example R404);
- select the type of operating mode (Mode), the superheat set point and complete the commissioning procedure;
- use the VPM program (Visual Parameter Manager, see the chapter "Network connection") and set the refrigerant type "0= Custom" and the parameters "Dew a...f high/low" which define the refrigerant (see variables accessible via serial connection);
- start control, for example by closing the digital input contact to enable operation.

Mode = operating mode	1 = Multiplexed cabinet/cold room
Superheat setpoint	11 K(20°F)

Note: consider the unit of measure (°C/°F) when setting the superheat setpoint (Si parameter).

5. FUNCTIONS

5.1 Control

EVD ice is a superheat controller. The type of refrigeration unit can be selected using the "Operating mode" parameter.

Parameter/description	Def.
Operating mode	1 = multiplexed cabinet/cold room
1 Multiplexed cabinet/cold room	multiplexed cabinet/ cold room
2 Air-conditioner/chiller with plate heat exchanger	
3 Air-conditioner/chiller with tube bundle heat exchanger	
4 Air-conditioner/chiller with finned coil heat exchanger	
5 Reserved	
6 Reserved	
7 Banco frigo/cella con CO2 (R744) sub-critica	

Tab. 5.a

Based on the operating mode setting, the driver automatically sets a series of control parameters.

Operating mode	PID: proport. gain	PID: integration time	Superheat set point	LowSH protection		LOP protection		MOP protection	
				threshold	Integration time	threshold	Integration time	threshold	Integration time
1 Multiplexed cabinet/cold room	15	150	11	5	15	-50	0	50	20
2 Air-conditioner/chiller with plate heat exchanger	3	40	6	2	2,5	-50	4	50	10
3 Air-conditioner/chiller with tube bundle heat exchanger	5	60	6	2	2,5	-50	4	50	10
4 Air-conditioner/chiller with finned coil heat exchanger	10	100	6	2	10	-50	10	50	20
5 Reserved	-	-	-	-	-	-	-	-	-
6 Reserved	-	-	-	-	-	-	-	-	-
7 Banco frigo/cella con CO2 (R744) sub-critica	20	400	13	7	15	-50	0	50	20

Tab. 5.b

Superheat

The primary purpose of the electronic valve is ensure that the flow-rate of refrigerant that flows through the nozzle corresponds to the flow-rate required by the compressor. In this way, the evaporation process will take place along the entire length of the evaporator and there will be no liquid at the outlet (consequently in the branch that runs to the compressor). As liquid is not compressible, it may cause damage to the compressor and even breakage if the quantity is considerable and the situation lasts some time.

Superheat control

The parameter that the control of the electronic valve is based on is the superheat temperature, which effectively tells whether or not there is liquid at the end of the evaporator. The superheat temperature is calculated as the difference between: superheated gas temperature (measured by a temperature probe located at the end of the evaporator) and the saturated evaporation temperature (calculated based on the reading of a pressure transducer located at the end of the evaporator and using the Tsat(P) conversion curve for each refrigerant).

$$\text{Superheat} = \text{Superheated gas temperature}^{(*)} - \text{Saturated evaporation temperature}$$

(*) suction

If the superheat temperature is high it means that the evaporation process is completed well before the end of the evaporator, and therefore flow-rate of refrigerant through the valve is insufficient. This causes a reduction in cooling efficiency due to the failure to exploit part of the evaporator. The valve must therefore be opened further. Vice-versa, if the superheat temperature is low it means that the evaporation process has not concluded at the end of the evaporator and a certain quantity of liquid will still be present at the inlet to the compressor. The valve must therefore be closed further. The operating range of the superheat temperature is limited at the lower end: if the flow-rate through the valve is excessive the superheat measured will be near 0 K. This indicates the presence of liquid, even if the percentage of this relative to the gas cannot be quantified. There is therefore an undetermined risk to the compressor that must be avoided. Moreover, a high superheat temperature as mentioned corresponds to an insufficient flow-rate of refrigerant. The superheat temperature must therefore always be greater than 0 K and have a minimum stable value allowed by the valve-unit system.

A low superheat temperature in fact corresponds to a situation of probable instability due to the turbulent evaporation process approaching the measurement point of the probes. The expansion valve must therefore be controlled with extreme precision and a reaction capacity around the superheat set point, which will almost always vary from 3 to 14 K. Set point values outside of this range are quite infrequent and relate to special applications.

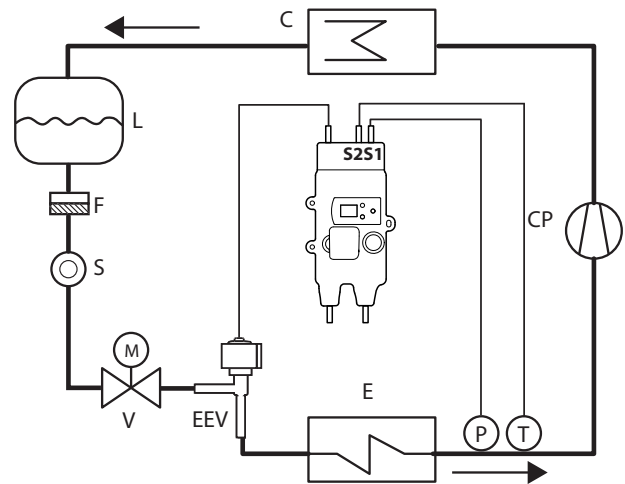

Fig. 5.a

Key

CP	compressor	EEV	electronic expansion valve
C	condenser	V	solenoid valve
L	liquid receiver	E	evaporator
F	dewatering filter	P	pressure probe (transducer)
S	liquid indicator	T	temperature probe

For the wiring, see "Wiring description".

PID parameters

Superheat control uses a PID algorithm. The control output is calculated as the sum of separate contributions: proportional and integral.

- the proportional action opens or closes the valve proportionally to the variation in the superheat temperature. Thus the greater the K (**proportional gain**) the higher the response speed of the valve. The proportional action does not consider the superheat set point, but rather only reacts to variations. Therefore if the superheat value does not vary significantly, the valve will essentially remain stationary and the set point cannot be reached;
- the integral action is linked to time and moves the valve in proportion to the deviation of the superheat value from the set point. The greater the deviations, the more intense the integral action; in addition, the lower the value of Ti (**integral time**), the more intense the action will be. The integral time, in summary, represents the intensity of the reaction of the valve, especially when the superheat value is not near the set point.

See the “EEV system guide” +030220810 for further information on calibrating PID control.

Par.	Description	Def.	Min.	Max.	UoM
-	Superheat set point	11(20)	LowSH: threshold	55 (99)	K(°F)
CP	PID proport. gain	15	0	800	-
ti	PID integral time	150	0	999	s

 **Note:** when selecting the type of Mode, the PID control values suggested by CAREL will be automatically set for each application.

Protector control parameters

See the chapter “Protectors”.

5.2 Service parameters

The other configuration parameters, to be set where necessary before starting the controller, concern :

- the type of ratiometric pressure probe;
- the serial address for network connection;
- the type of unit of measure;
- enabling change in type of control (Mode);
- the number of steps (480/960) to control valve position.

Type of pressure probe (par. S1)

S1 is used to select the type of ratiometric pressure probe.

Par.	Description	Def.	Min.	Max.	UoM
S1	type of probe S1	3	1	13	-
	1 = -1...4.2 barg				
	2 = 0.4...9.3 barg				
	3 = -1...9.3 barg				
	4 = 0...17.3 barg				
	5 = 0.85...34.2 barg				
	6 = 0...34.5 barg				
	7 = 0...45 barg				
	8 = -1...12.8 barg				
	9 = 0...20.7 barg				
	10 = 1.86...43.0 barg				
	11 = Reserved				
	12 = 0...60 barg				
	13 = 0...90 barg				

 **Note:** when setting the probe type, the maximum and minimum limits for the pressure alarm are automatically defined. See “Variables accessible via serial connection”.

Network address (par. n1)

See the “Network connection” chapter.

Unit of measure (par. Si)

It is possible to select the measure system of the driver:

- international (°C, K, barg);
- imperial (°F, psig).

Par.	Description	Def.	Min.	Max.	UoM
Si	Unit of measure 1=°C/K/barg 2=°F/psig	1	1	2	-

 **Note:** the unit of measure K relates to degrees Kelvin adopted for measuring the superheat and the related parameters.

When changing the unit of measure, all the values of the parameters saved on the driver and all the measurements read by the probes will be recalculated. This means that when changing the units of measure, control remains unaltered.

Example 1: The pressure read is 20 barg this will be immediately converted to the corresponding value of 290 psig.

Example 2: The “superheat set point” parameter set to 10 K will be immediately converted to the corresponding value of 18 °F.

Access to the Mode (operating mode) parameter (par. IA)

To avoid accidental modification of the controller’s operating mode, it is possible to disable the access to the corresponding parameter.

Par.	Description	Def.	Min.	Max.	UoM
IA	Enable operating mode modification 0/1 = yes/ no	0	0	1	-

Number of control steps (par. U3)

Total number of steps between the valve fully closed and fully open position

Par.	Description	Def.	Min.	Max.	UoM
U3	Number of valve control steps 1 / 2 = 480/960 steps	1	1	2	-

Digital input

The function of the digital input can be set by parameter:

Par.	Description	Def.	Min.	Max.	UoM
d1	DI configuration 1=Start/Stop regulation 2=Regulation backup	1	1	2	-

Start/stop regulation:

- digital input closed: control active;
- digital input open: control in standby (see the paragraph “Control states”).

 **Important:** this setting excludes activation/deactivation of control via the network. See the following function.

Regulation backup: if there is a network connection and communication fails, the driver checks the status of the digital input to determine whether control is active or in standby.

6. PROTECTORS

These are additional functions that are activated in specific situations that are potentially dangerous for the unit being controlled. They feature an integral action, that is, the action increases gradually when moving away from the activation threshold. They may add to or overlap (disabling) normal PID superheat control. By separating the management of these functions from PID control, the parameters can be set separately, allowing, for example, normal control that is less reactive yet much faster in responding when exceeding the activation limits of one of the protectors.

6.1 Protectors

The protectors are 3:

- LowSH, low superheat;
- LOP, low evaporation temperature;
- MOP, high evaporation temperature;

The protectors have the following main features:

- activation threshold: depending on the operating conditions of the controlled unit, this is set in Service programming mode;
- integration time, which determines the intensity (if set to 0, the protector is disabled): set automatically based on the type of main control;
- alarm, with activation threshold (the same as the protector) and timeout (if set to 0 disables the alarm signal).

Note: The alarm signal is independent from the effectiveness of the protector, and only signals that the corresponding threshold has been exceeded. If a protector is disabled (null integration time), the relative alarm signal is also disabled.

Each protector is influenced by the proportional gain parameter (CP) of PID superheat control. The higher is the value of CP, the more intensely the protection will react.

Characteristics of the protectors

Protection	Reaction	Reset
LowSH	Intense closing	Immediate
LOP	Intense opening	Immediate
MOP	Moderate closing	Controlled

Tab. 6.a

Reaction: summary description of the type of action in controlling the valve.

Reset: summary description of the type of reset following the activation of the protector. Reset is controlled to avoid swings around the activation threshold or immediate reactivation of the protector.

Note: all the alarms are generated after a fixed delay, as shown in the table:

Protectors	Delay (s)
LowSH	300
LOP	300
MOP	600

LowSH (low superheat)

The protector is activated so as to prevent the low superheat from causing the return of liquid to the compressor.

Par.	Description	Def.	Min.	Max.	U.M.
C1	LowSH protection: threshold	5(9)	-5(-9)	Set point superheat	K(°F)
C2	LowSH protection: integration time	15	0	800	s

When the superheat value falls below the threshold, the system enters low superheat status, and the intensity with which the valve is closed is increased: the more the superheat falls below the threshold, the more intensely the valve will close. The LowSH threshold must be less than or equal to the superheat set point. The low superheat integration time indicates the intensity of the action: the lower the value, the more intense the action.

The integration time is set automatically based on the type of main control.

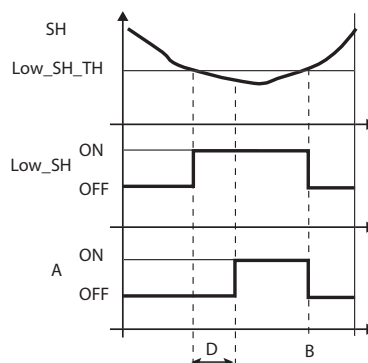

Fig. 6.a

key:

SH	Superheat	A	Alarm
Low_SH_TH	Low_SH protection threshold	D	Alarm delay
Low_SH	Low_SH protection	t	Time
B	Alarm automatic reset		

LOP (low evaporation pressure)

LOP= Low Operating Pressure

The LOP protection threshold is applied as a saturated evaporation temperature value so that it can be easily compared against the technical specifications supplied by the manufacturers of the compressors. The protector is activated so as to prevent too low evaporation temperatures from stopping the compressor due to the activation of the low pressure switch. The protector is very useful in units with compressors on board (especially multi-stage), where when starting or increasing capacity the evaporation temperature tends to drop suddenly.

When the evaporation temperature falls below the low evaporation temperature threshold, the system enters LOP status and is the intensity with which the valve is opened is increased. The further the temperature falls below the threshold, the more intensely the valve will open. The integration time indicates the intensity of the action: the lower the value, the more intense the action.

Par.	Description	Def.	Min.	Max.	U.M.
C3	LOP protection: threshold	-50 (-58)	-85 (-121)	MOP protec.: threshold	C(°F)
C4	LOP protection: integration time	0	0	800	s

The integration time is set automatically based on the type of main control.

Note:

- the LOP threshold must be lower than the rated evaporation temperature of the unit, otherwise it would be activated unnecessarily, and greater than the calibration of the low pressure switch, otherwise it would be useless. As an initial approximation it can be set to a value exactly half-way between the two limits indicated;
- the protector has no purpose in multiplexed systems (showcases) where the evaporation is kept constant and the status of the individual electronic valve does not affect the pressure value;
- the LOP alarm can be used as an alarm to highlight refrigerant leaks by the circuit. A refrigerant leak in fact causes an abnormal lowering of the evaporation temperature that is proportional, in terms of speed and extent, to the amount of refrigerant dispersed.

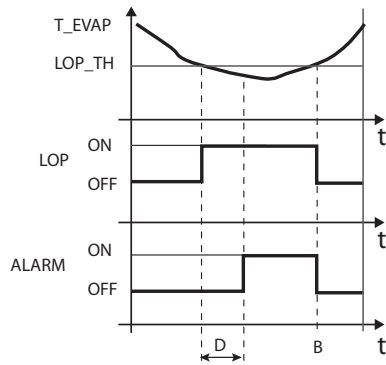

Fig. 6.b

Key:

T_EVAP	Evaporation temperature	D	Alarm timeout
LOP_TH	Low evaporation temperature protection	ALARM	Alarm
LOP	LOP protection	t	Time
B	Automatic alarm reset		

MOP (high evaporation pressure)

MOP= Maximum Operating Pressure.

The MOP protection threshold is applied as a saturated evaporation temperature value so that it can be easily compared against the technical specifications supplied by the manufacturers of the compressors. The protector is activated so as to prevent too high evaporation temperatures from causing an excessive workload for the compressor, with consequent overheating of the motor and possible activation of the thermal protector. The protector is very useful in self-contained units if starting with a high refrigerant charge or when there are sudden variations in the load. The protector is also useful in multiplexed systems (showcases), as allows all the utilities to be enabled at the same time without causing problems of high pressure for the compressors. To reduce the evaporation temperature, the output of the refrigeration unit needs to be decreased. This can be done by controlled closing of the electronic valve, implying superheat is no longer controlled, and an increase in the superheat temperature. The protector will thus have a moderate reaction that tends to limit the increase in the evaporation temperature, keeping it below the activation threshold while trying to stop the superheat from increasing as much as possible. Normal operating conditions will not resume based on the activation of the protector, but rather on the reduction in the refrigerant charge that caused the increase in temperature. The system will therefore remain in the best operating conditions (a little below the threshold) until the load conditions change.

Par.	Description	Def.	Min.	Max.	U.M.
C5	MOP protection threshold	50 (122)	Protection LOP: threshold	200 (392)	C(°F)
C6	MOP protection integration time	20	0	800	s

The integration time is set automatically based on the type of main control.

When the evaporation temperature rises above the MOP threshold, the system enters MOP status, superheat control is interrupted to allow the pressure to be controlled, and the valve closes slowly, trying to limit the evaporation temperature.

As the action is integral, it depends directly on the difference between the evaporation temperature and the activation threshold. The more the evaporation temperature increases with reference to the MOP threshold, the more intensely the valve will close. The integration time indicates the intensity of the action: the lower the value, the more intense the action.

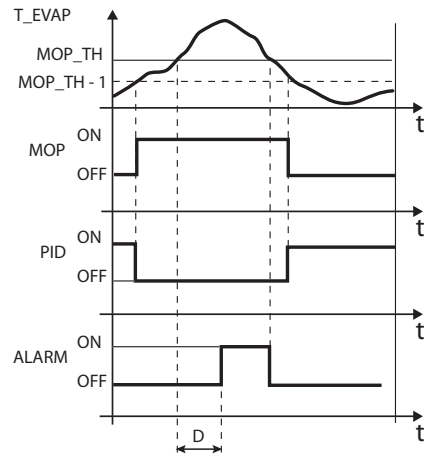

Fig. 6.c

Key:

T_EVAP	Evaporation temperature	MOP_TH	MOP threshold
PID	PID superheat control	ALARM	Alarm
MOP	MOP protection	t	Time
D	Alarm timeout		

⚠ Important: the MOP threshold must be greater than the rated evaporation temperature of the unit, otherwise it would be activated unnecessarily. The MOP threshold is often supplied by the manufacturer of the compressor. It is usually between 10 °C and 15 °C.

If the closing of the valve also causes an excessive increase in the suction temperature (S2) above the set threshold – set via parameter (C7), not on the display - the valve will be stopped to prevent overheating the compressor windings, awaiting a reduction in the refrigerant charge. If the MOP protection function is disabled by setting the integral time to zero, the maximum suction temperature control is also deactivated.

Par.	Description	Def.	Min.	Max.	U.M.
C7	MOP protection: disabling threshold	30 (86)	-85 (-121)	200 (392)	°C (°F)

At the end of the MOP protection function, superheat control restarts in a controlled manner to prevent the evaporation temperature from exceeding the threshold again.

7. PARAMETERS TABLE

Par.	Description	Def.	Min.	Max.	UoM	Type	Carel	Modbus®	R/W	Note
BASED (FISRT CONFIGURATION)										
GAS Type	Refrigerant	3	0	40	-	I	12	139	R/W	
	0 Custom									
	1 R22	15	R422D	28	R1234ze(-1...4.2 barg)					
	2 R134a	16	R413A	29	R455A (-1...12.8 barg)					
	3 R404A	17	R422A	30	R170 (0...17.3 barg)					
	4 R407C	18	R423A	31	R442A (-1...12.8 barg)					
	5 R410A	19	R407A	32	R447A (-1...12.8 barg)					
	6 R507A	20	R427A	33	R448A					
	7 R290	21	R245FA	34	R449A					
	8 R600(-1...4.2 barg)	22	R407F	35	R450A (-1...4.2 barg)					
	9 R600a (-1...4.2 barg)	23	R32 (0...17.3 barg)	36	R452A (-1...12.8 barg)					
	10 R717	24	HTR01	37	R508B (-1...4.2 barg)					
	11 R744 (0...45 barg)	25	HTR02	38	R452B					
	12 R728	26	R23	39	R513A (-1...4.2 barg)					
	13 R1270	27	R1234yf	40	R454B					
14 R417A										
Mode	Operating mode	1	1	7	-	I	13	140	R/W	
	1 Multiplexed cabinet/cold room									
	2 Air-conditioner/chiller with plate heat exchanger									
	3 Air-conditioner/chiller with tube bundle heat exchanger									
	4 Air-conditioner/chiller with finned coil heat exchanger									
	5 Reserved									
	6 Reserved									
	7 Cabinet/cold room with subcritical (R744) CO2									
Super Heat	Superheat set point	11 (20)	LowSH: protection threshold	55 (99)	K (°F)	A	10	9	R/W	

SERVICE

P1	S1 probe measurement	-	-85 (-290)	200 (2900)	barg (psig)	A	6	5	R	
P2	S2 probe measurement	-	-85 (-121)	200 (392)	°C(°F)	A	7	6	R	
tE	Evaporation temperature (converted)	-	-85 (-121)	200 (392)	°C(°F)	A	4	3	R	
tS	Suction temperature	-	-85 (-121)	200 (392)	°C(°F)	A	3	2	R	
Po	Valve opening	-	0	100	%	A	1	0	R	
CP	PID proportional gain	15	0	800	-	A	11	10	R/W	
ti	PID integral time	150	0	999	s	I	17	144	R/W	
C1	LowSH protection: threshold	5(9)	-5 (-9)	Superheat set point	K (°F)	A	12	11	R/W	
C2	LowSH protection: integral time	15	0	800	s	A	13	12	R/W	
C3	LOP protection: threshold	-50(-58)	-85(-121)	MOP protection threshold	°C (°F)	A	14	13	R/W	
C4	LOP protection: integral time	0	0	800	s	A	15	14	R/W	
C5	MOP protection: threshold	50 (122)	LOP protection: threshold	200 (392)	°C (°F)	A	16	15	R/W	
C6	MOP protection: integral time	20	0	800	s	A	17	16	R/W	
C7	MOP protection: disabling threshold	30 (86)	-85 (-121)	200 (392)	°C (°F)	A	19	18	R/W	
C8	Low suction temperature alarm threshold	-50 (-58)	-85 (-121)	200 (392)	°C (°F)	A	18	17	R/W	
S1	S1 probe type	3	1	11	-	I	14	141	R/W	
	Ratiometric (OUT=0...5V)									
	1 = -1...4.2 barg	8 = -1...12.8 barg								
	2 = 0.4...9.3 barg	9 = 0...20.7 barg								
	3 = -1...9.3 barg	10 = 1.86...43.0 barg								
	4 = 0...17.3 barg	11 = Reserved								
	5 = 0.85...34.2 barg	12 = 0...60 barg								
	6 = 0...34.5 barg	13 = 0...90 barg								
7 = 0...45 barg										
n1	Network address	99	1	99	-	I	10	137	R/W	
n2	Baud rate (bit/s)	2	0	17	-	I	20	147	R/W	
	0 4800, 2 stop bit, parity none	9 4800, 1 stop bit, parity even								
	1 9600, 2 stop bit, parity none	10 9600, 1 stop bit, parity even								
	2 19200, 2 stop bit, parity none	11 19200, 1 stop bit, parity even								
	3 4800, 1 stop bit, parity none	12 4800, 2 stop bit, parity odd								
	4 9600, 1 stop bit, parity none	13 9600, 2 stop bit, parity odd								
	5 19200, 1 stop bit, parity none	14 19200, 2 stop bit, parity odd								
	6 4800, 2 stop bit, parity even	15 4800, 1 stop bit, parity odd								
	7 9600, 2 stop bit, parity even	16 9600, 1 stop bit, parity odd								
8 19200, 2 stop bit, parity even	17 19200, 1 stop bit, parity odd									
Si	Unit of measure 1=°C/K/barg; 2=°F/psig	1	1	2	-	I	16	143	R/W	
IA	Enable operating mode modification 0/1 = yes/ no	0	0	1	-	I	15	142	R/W	

Par.	Description	Def.	Min.	Max.	UoM	Type	Carel	Modbus®	R/W	Note
U1	Enable manual valve positioning 0/1 = no/ yes	0	0	1	-	D	11	10	R/W	
U2	Manual valve position	0	0	999	step	I	7	134	R/W	
U3	Valve control steps: 1/2 = 480/960 steps	1	1	2	-	I	11	138	R/W	
U4	Valve opening at start-up (evaporator/valve capacity ratio)	50	0	100	%	I	19	146	R/W	
Fr	Firmware release	-	-	-	-	A	9	8	R	
di	DI configuration 1=start/stop regulation 2=backup regulation	1	1	2	-	I	18	145	R/W	
rt	Reserved	1	1	1	-					
L1	S1 alarm: Minimum pressure	-1	-85(-121)	S1 alarm: Max pres- sure	barg (psig)	A	20	19	R/W	
H1	S1 alarm: Maximum pressure	-	S1 alarm: Min pres- sure	200 (392)	barg (psig)	A	21	20	R/W	

Tab. 7.a

8. NETWORK CONNECTION

The driver can be connected via a network connection to:

1. a computer running the VPM software, for setting the parameters before commissioning;
2. a pCO controller, loaded with the application program;
3. a PlantVisor/PlantVisorPRO supervisor, for remote monitoring and alarm detection.

8.1 RS485 serial configuration

n1 assigns to the controller an address for serial connection to a supervisory and/or telemaintenance system.

Par.	Description	Def.	Min.	Max.	UoM
n1	Network address	1	1	99	-
n2	Baud rate (bit/s)	2	0	17	-
0	4800, 2 stop bit, parity none				
1	9600, 2 stop bit, parity none				
2	19200, 2 stop bit, parity none				
3	4800, 1 stop bit, parity none				
4	9600, 1 stop bit, parity none				
5	19200, 1 stop bit, parity none				
6	4800, 2 stop bit, parity even				
7	9600, 2 stop bit, parity even				
8	19200, 2 stop bit, parity even				
9	4800, 1 stop bit, parity even				
10	9600, 1 stop bit, parity even				
11	19200, 1 stop bit, parity even				
12	4800, 2 stop bit, parity odd				
13	9600, 2 stop bit, parity odd				
14	19200, 2 stop bit, parity odd				
15	4800, 1 stop bit, parity odd				
16	9600, 1 stop bit, parity odd				
17	19200, 1 stop bit, parity odd				

Important: all controllers connected in a serial network need to be set with the same communication parameters.

8.2 Network connection for commissioning via PC

Warnings:

- fasten the converter properly so as to prevent disconnection;
- complete the wiring without power connected;
- keep the CVSTDUMORO interface cables separate from the power cables (power supply);
- in compliance with standards on electromagnetic compatibility, a shielded cable suitable for RS485 data transmission is used.

The RS485 converter is used to connect a computer running the VPM software to the EVD ice driver via a serial network, for commissioning the controllers. The system allows a maximum of 99 units, with a maximum network length of 500 m. Connection requires the standard accessories (RS485-USB converter, CAREL P/N CVSTDUMORO) and a 120 Ω terminating resistor to be installed on the terminals of the last connected controller. Connect the RS485 converter to controllers and make the connections as shown in the figure. To assign the serial address, see parameter n1. See the converter technical leaflets for further information.

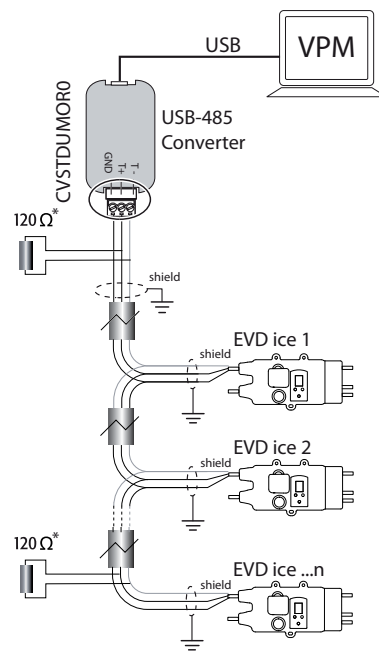

Fig. 8.a

8.3 Visual parameter manager

Go to <http://ksa.carel.com> and follow the instructions below. Select in sequence:

1. "Software & Support"
2. "Configuration & Updating Softwares"
3. "Parametric Controller Software"
4. "Visual Parametric Manager"

A window will open with the possibility to download two files:

1. VPM_setup_X.Y.Z.W_full.zip: complete program;
2. X.Y.Z.W_VPM_Devices_Upgrade.zip: upgrade for supported devices;

If this is the first installation, select Setup full, otherwise Upgrade. The program installs automatically by running setup.exe.

Note: if choosing complete installation (Setup full), uninstall any previous versions of VPM.

Programming

When opening the program, the device to be configured needs to be selected: EVD mini. The Home page then opens, offering the choice between starting a new project or opening an existing project. If using the program for the first time, choose new project.

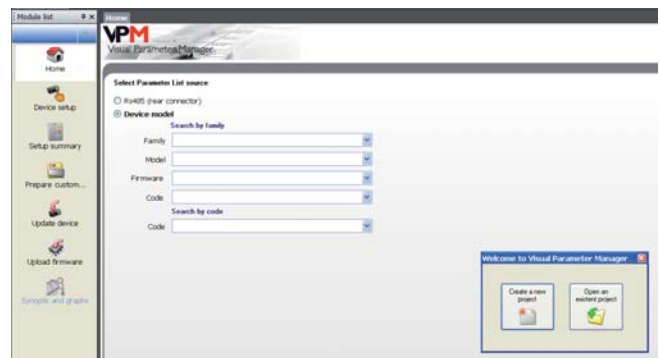

Fig. 8.b

The following options are then available:

1. Directly access the list of parameters saved in EEPROM: select "RS485";

The operations are performed in real time (ONLINE mode), at the top right set network address 1 and choose the guided procedure for USB port recognition, then go to "Device setup";

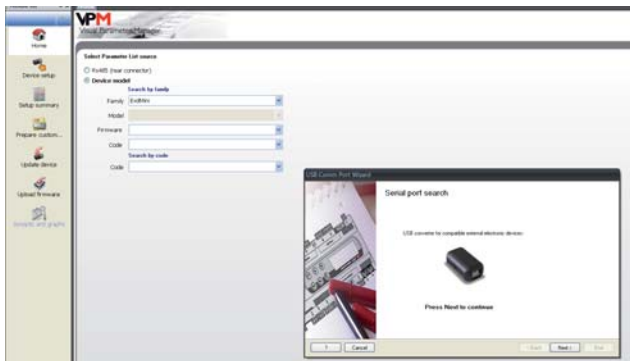

Fig. 8.c

2. Select the model from the range based on the firmware version and list of configuration parameters (EVDMINI0000E0X_R*). These operations are performed in OFFLINE mode.

Menu

The pages marked 1) can be accessed with Online or Offline, while those marked 2) are Online only.



Fig. 8.d

The operations that can be performed on the pages marked 1) depend on the first selection made.

Note: to access the Online help press F1.

Ref.	Description	
Home	Select operating mode	Online → RS485 (rear connector) Offline → Device model
		Online Offline
Device setup	Read instant values of control parameters	Select Load to load a list of project parameters (.hex), modify and save a new project.
Setup summary	Display the default values for the current list of parameters	
Prepare custom setup	See online help.	
Update device	Select list of parameters and then Upload to controller	
Upload firmware	Select firmware and Upload	
Synoptic and graphs	Overview with position of probes and probe and superheat readings in real time	

Tab. 8.b

8.4 Restore default parameters

To restore the default parameter values on the controller:

1. Establish an RS485 serial connection between the computer and the driver. The LEDs on the USB/RS485 converter will flash;

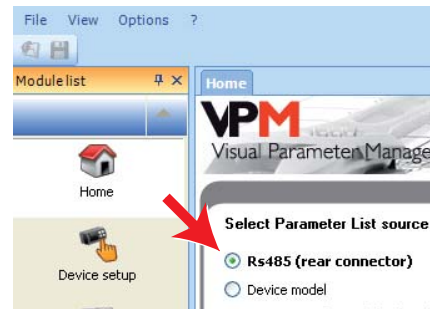

Fig. 8.e

2. Select "Update device" and:
 - a. Click button (A) to open the drop-down menu;
 - b. Select the list of parameters corresponding to the controller's firmware version: "EVDMINI***.hex";
 - c. Click "Update" to load the parameters to the list and immediately after restore the controller parameters to the default value.

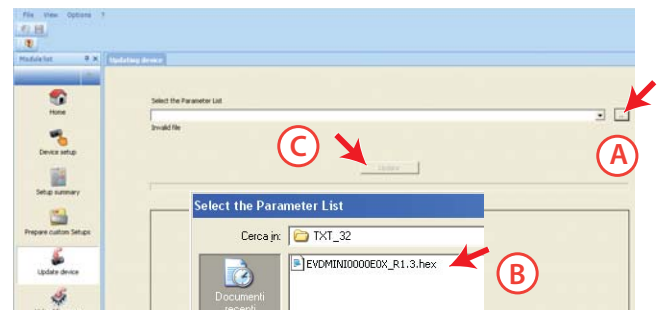

Fig. 8.f

3. Go to "Device setup": the program automatically reads the default parameters saved on the controller.

8.5 Setup by direct copy

1. On the Home page select RS485 (rear connector);

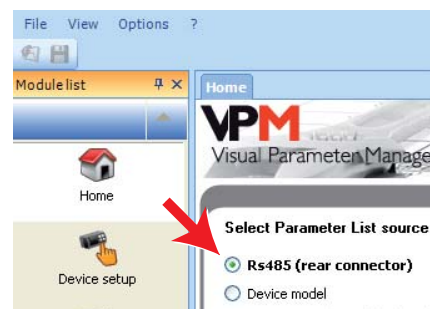

Fig. 8.g

2. Go to "Device setup";

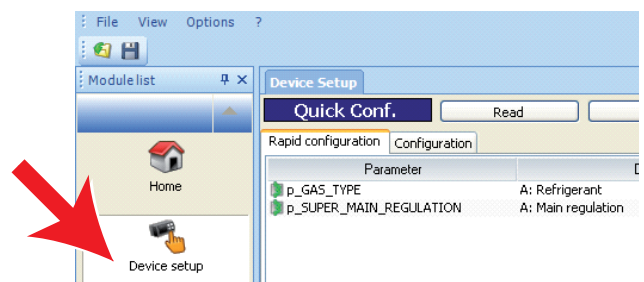

Fig. 8.h

- a. on the “Rapid configuration” page, set parameters “p_GAS_TYPE” = refrigerant and “p_SUPER_MAIN_REGULATION” = type of control;

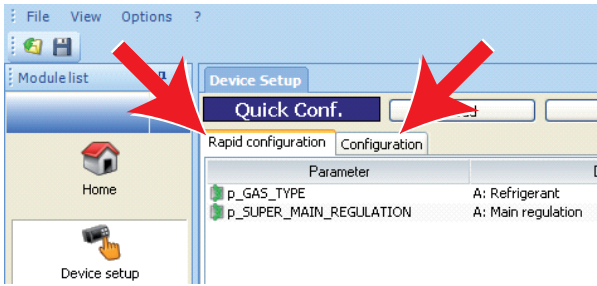

Fig. 8.i

- b. on the “Configuration” page, set parameter “p_SH_SET”.

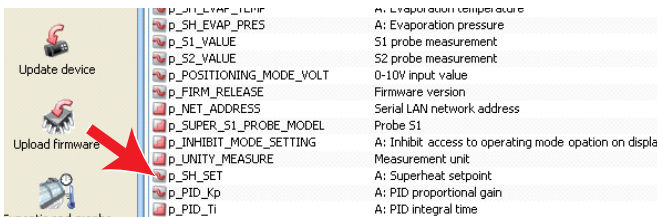

Fig. 8.j

3. Check whether there are other parameters that need to be set (see the “Functions” chapter);
4. Finally, select “Write” to copy the parameters to the controller.

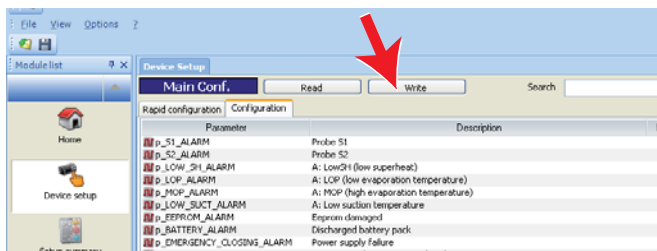

Fig. 8.k

8.6 Setup using configuration file

On the Home page select “Device model”.



Fig. 8.l

- The setup procedure comprises three steps:
1. Create the configuration file;
 2. Copy the configuration file to the controller;
 3. Read the configuration file on the controller.

Create the configuration file

1. Select the “Device setup” page;
2. Set the parameters by double clicking, as shown in the figure:
 - a. on the “Rapid configuration” page, parameters “p_GAS_TYPE” = refrigerant and “p_SUPER_MAIN_REGULATION” = type of control;
 - b. on the “Configuration” page, parameter “p_SH_SET”.

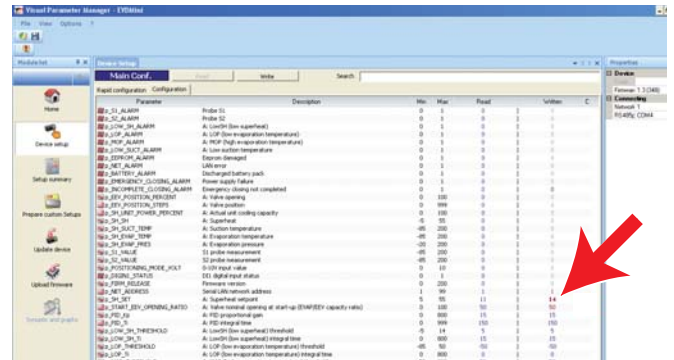
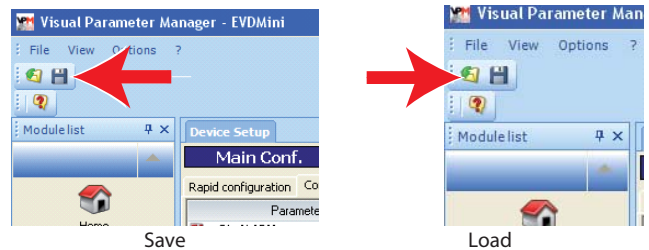

Fig. 8.m

3. Save the list of parameters with a new name, for example “NEW_NAME.hex”. To load and display a list saved by the user, select “Load” and navigate to the path where the file is saved. On the other hand, to load a list of parameters supplied by CAREL, select “Load” and navigate the following path:

Load→Plugins→Commissioning EVD mini →TXT→TXT32.



Copy the configuration file to the controller

Select “Update device” and:

- a. Click button (A) to open the drop-down menu;

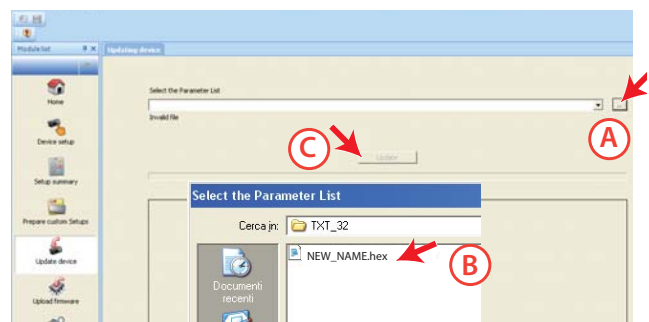

Fig. 8.n

- b. Select the list of parameters corresponding to the project file created: “NEW_NAME.hex”;
- c. Click “Update” to UPLOAD the parameters to the controller.

8.7 Read the configuration file on the controller

1. Go to the “Home” page and select RS485 (rear connector);
2. Go to “Device setup” to read the list of parameters on the controller and make sure the settings are correct.

8.8 Variables accessible via serial connection

Parameter	Description	Def.	Min	Max	Type	Carel	Modbus®	R/W	Note
Reg_status	Device control status	0	0	20	I	1	128	R	
Machine_type_SPV	Type of unit	0	0	32767	I	2	129	R	
Hardware_code_SPV	Hardware code	0	0	32767	I	3	130	R	
EEV_Positions_steps	Valve position	0	0	999	I	4	131	R	
Protection_status	Protector status	0	0	5	I	5	132	R	
Sh_unit_power_percent	Cooling capacity	0	0	100	I	6	133	R/W	
Man_posit_steps	Manual valve position	0	0	999	I	7	134	R/W	par. U2
Start_func_test	Functional test input variable	0	0	30000	I	8	135	R/W	
Func_test_2	Functional test generic variable	0	-32768	32767	I	9	136	R/W	
Net_address	LAN serial address	99	1	99	I	10	137	R/W	par. n1
EEV_steps_doubling	Double valve steps	1	1	2	I	11	138	R/W	par. U3
Gas_type	Refrigerant	3	1	23	I	12	139	R/W	Gas Type = refrigerant
Super_main_regulation	Main control	1	0	6	I	13	140	R/W	Operating mode
Super_S1_probe_model	Probe S1	3	1	11	I	14	141	R/W	par. S1
Inhibit_mode_setting	Enable mode parameter setting	0	0	1	I	15	142	R/W	par. IA
Unity_measure	Unit of measure	1	1	2	I	16	143	R/W	par. Si
PID_Ti	PID: integral time	150	0	999	I	17	144	R/W	par. ti
Par_Digin1_Config	Digital input configuration 1=Start/stop control 2=Control backup	1	1	2	I	18	145	R/W	
Start_eev_opening_ratio	Valve position at start-up	50	0	100	I	19	146	R/W	par. U4
Net_setting	Baud rate	2	0	17	I	20	147	R/W	par. n2
Reset_Default (*)	Reset with default parameters	0	-32768	32767	I	21	148	R/W	
Ultracella_signature	Riservato	0	-32768	32767	I	22	149	R/W	
Control_type	Control type	1	1	9	I	23	150	R	
Gas_custom_dew_a_h	Dew a high	-288	-32768	32767	I	24	151	R/W	
Gas_custom_dew_a_l	Dew a low	-15818	-32768	32767	I	25	152	R/W	
Gas_custom_dew_b_h	Dew b high	-14829	-32768	32767	I	26	153	R/W	
Gas_custom_dew_b_l	Dew b low	16804	-32768	32767	I	27	154	R/W	
Gas_custom_dew_c_h	Dew c high	-11664	-32768	32767	I	28	155	R/W	
Gas_custom_dew_c_l	Dew c low	16416	-32768	32767	I	29	156	R/W	
Gas_custom_dew_d_h	Dew d high	-23322	-32768	32767	I	30	157	R/W	
Gas_custom_dew_d_l	Dew d low	-16959	-32768	32767	I	31	158	R/W	
Gas_custom_dew_e_h	Dew e high	-16378	-32768	32767	I	32	159	R/W	
Gas_custom_dew_e_l	Dew e low	15910	-32768	32767	I	33	160	R/W	
Gas_custom_dew_f_h	Dew f high	-2927	-32768	32767	I	34	161	R/W	
Gas_custom_dew_f_l	Dew f low	-17239	-32768	32767	I	35	162	R/W	
Net_alarm	Network alarm	0	0	1	D	1	0	R	all. E6
Emergency_closing_alarm	Mains power failure	0	0	1	D	2	1	R	all. E5
S1_alarm	Probe S1 alarm	0	0	1	D	3	2	R	all. A1
S2_alarm	Probe S2 alarm	0	0	1	D	4	3	R	all. A2
Low_sh_alarm	Low SH alarm	0	0	1	D	5	4	R	all. E3
LOP_alarm	LOP alarm	0	0	1	D	6	5	R	all. E2
MOP_alarm	MOP alarm	0	0	1	D	7	6	R	all. E1
Low_suct_alarm	Low suction temperature alarm	0	0	1	D	8	7	R	all. E4
Eeprom_alarm	EEPROM damaged	0	0	1	D	9	8	R	all. EE
Digin1_status	Digital input status	0	0	1	D	10	9	R	
Manual_posit_enable	Enable manual valve	0	0	1	D	11	10	R/W	par. U1
Incomplete_closing_alarm	Emergency closing not completed	0	0	1	D	12	11	R/W	all. E8
Battery_alarm	Battery alarm	0	0	1	D	13	12	R	
EVD_CAN_GO	EVD regulation enable	0	0	1	D	14	13	R/W	
EEV_Position_percent	Valve opening	0	0	100	A	1	0	R	par. Po
SH_SH	Superheat	0	-5 (-9)	55 (99)	A	2	1	R	
Sh_Suct_temp	Suction temperature	0	-85 (-121)	200 (392)	A	3	2	R	par. t5
Sh_Evap_temp	Evaporation temperature	0	-85 (-121)	200 (392)	A	4	3	R	
Sh_Evap_pres	Evaporation pressure	0	-20 (-290)	200 (2900)	A	5	4	R	
S1_Value	Probe S1 reading	0	-85 (-290)	200 (2900)	A	6	5	R	par. P1
S2_Value	Probe S2 reading	0	-85 (-121)	200 (392)	A	7	6	R	par. P2
Positioning_mode_volt	0 to 10 V input	0	0	10	A	8	7	R	
Firm_release	Firmware version	0	0	800	A	9	8	R	par. Fr
SH_Set	Superheat set point	11	Low_Sh_Threshold	55	A	10	9	R/W	Super heat = Superheat set point
PID_Kp	PID: proportional gain	15	0	800	A	11	10	R/W	par. CP
Low_sh_threshold	Low superheat: threshold	5	-5 (-9)	SH set point	A	12	11	R/W	par. C1
Low_sh_Ti	Low superheat: integral time	15	0	800	A	13	12	R/W	par. C2
Lop_threshold	LOP: threshold	-50(-58)	-85(-121)	MOP_threshold	A	14	13	R/W	par. C3
Lop_Ti	LOP: integral time	0	0	800	A	15	14	R/W	par. C4
MOP_Threshold	MOP: threshold	50	LOP_threshold	200 (392)	A	16	15	R/W	par. C5

(*) set to 1073 to reset the parameters to default values

Parameter	Description	Def.	Min	Max	Type	Carel	Modbus®	R/W	Note
MOP_Ti	MOP: integral time	20	0	800	A	17	16	R/W	par. C6
Low_Suct_alarm_threshold	Low suction temp. alarm threshold	-50(-58)	-85 (-121)	200 (392)	A	18	17	R/W	par. C8
Mop_Inhibition_threshold	MOP: disabling threshold	30 (86)	-85 (-121)	200 (392)	A	19	18	R/W	
Par_S1_Alarm_threshold_low	Pressure S1: MINIMUM alarm value low	-1	-85(-121)	Par_S1_Alarm_threshold_high	A	20	19	R/W	
Par_S1_Alarm_threshold_high	Pressure S1: MAXIMUM alarm value high	9.3	Par_S1_Alarm_threshold_low	200(392)	A	21	20	R/W	

Tab. 8.c

8.9 Control states

The electronic valve controller can have six different control states, each of which may correspond to a specific phase in the operation of the refrigeration unit and a certain status of the driver-valve system. The states are as follows:

- forced closing: initialisation of the valve position when switching the instrument on;
- standby: no temperature control, unit OFF (at temp.);
- wait: opening of the valve before starting control, also called pre-positioning, when powering the unit on;
- control: effective control of the electronic valve, unit ON;
- positioning: step-change in the valve position, corresponding to the start of control when the cooling capacity of the controlled unit varies (only EVD connected to a pCO);
- stop: of control with closing of the valve, corresponds to the end of temperature control of the refrigeration unit, unit OFF (at temp.).

Forced closing

Forced closing is performed after the driver is powered on and corresponds to the typical number of closing steps for CAREL E2V and E3V unipolar valves. This is used to realign the valve to the physical position corresponding to completely closed. The driver and the valve are then ready for control and both aligned at 0 (zero). At power-on, first a forced closing is performed, and then the standby phase starts. The valve is also closed in the event of a mains power failure if the Ultracap module is connected. In this case, the "Forced valve closing not completed" parameter is set to 1.

On restarting, if the valve forced closing procedure is not completed successfully:

1. the Master programmable controller (pCO) will check the value of the parameter, and if equal to 1 will decide the best strategy to adopt, based on the application;
2. on restarting the driver positions the valve as explained in the paragraph "Pre-positioning/start control". The parameter is set to 0 (zero) by the Master controller (e.g. pCO), or alternatively by pressing the PRG/Set button on the keypad. Once the parameter has been set to 1, the driver sets it back to 0 (zero) only if an emergency forced closing procedure is completed successfully.

 **Note:** The user can only select the resolution of the valve control signal: 480 or 960 steps.

Par.	Description	Def.	Min.	Max.	UoM
U3	Valve control steps 1 / 2 = 480/ 960 steps	1	1	2	-

Standby

Standby corresponds to a situation of rest in which no signals are received to control the electronic valve: it is closed and manual positioning can be activated. This status is normally set on the driver when the refrigeration unit is shutdown manually (e.g. from the supervisor) or when reaching the control set point. It can also occur when opening the digital input (which involves closing the valve) or in the event of a probe alarm. In general, it can be said that the electronic valve driver is in standby when the compressor stops or the control solenoid valve closes.

Pre-positioning/start control

If during standby a control request is received, before starting control the valve is moved to a precise initial position. Internally, the pre-positioning time is set at 6 s and represents the time that the valve is held in a fixed position. By default the valve is opened 50 % when starting (from digital input), so as to minimise the movement needed to reach the correct position.

Par.	Description	Def.	Min.	Max.	UoM
U4	Valve opening at start-up	50	0	100	%

This parameter should be set based on the ratio between the rated cooling capacity of the evaporator and the valve (e.g. rated evaporator cooling capacity: 3kW, rated valve cooling capacity: 10kW, valve opening = 3/10 = 33%).

The driver calculates the valve opening based on the required capacity:

If required capacity is 100%:

Opening (%)= (Valve opening at start-up);

If required capacity is less than 100% (capacity control):

Opening (%)= (Valve opening at start-up) x (Current unit cooling capacity), where the current unit cooling capacity is sent to the driver via RS485 by the pCO controller. If the driver is stand-alone, this is always equal to 100%.

Notes:

- this procedure is used to anticipate the movement and bring the valve significantly closer to the operating position in the phases immediately after the unit is powered on;
- if there are problems with liquid return after the refrigeration unit starts or in units that frequently switch on-off, the valve opening at start-up must be decreased. If there are problems with low pressure after the refrigeration unit starts, the valve opening must be increased.

Wait

When the calculated position has been reached, regardless of the time taken (this varies according to the type of valve and the objective position), there is a constant 5 second delay before the actual control phase starts. This is to create a reasonable interval between standby, in which the variables have no meaning, as there is no flow of refrigerant, and the effective control phase.

Control

The control request can be received by the closing of the digital input or via network (RS485). The solenoid or the compressor are activated when the valve, following the pre-positioning procedure, has reached the calculated position. The following figure represents the sequence of events for starting control of the refrigeration unit.

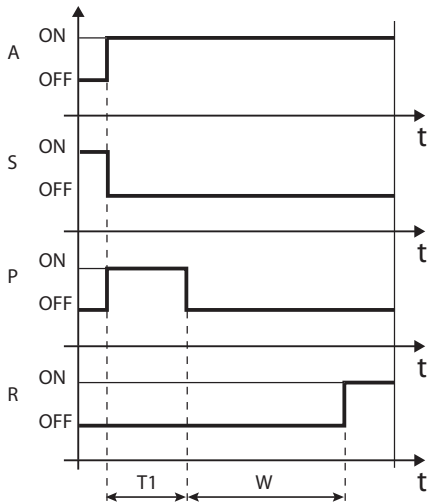

Fig. 8.o

Key:

A	Control request	T1	Pre-positioning time
P	Pre-positioning	W	Wait (wait)
S	Standby	t	Time
R	Control		

Positioning (change cooling capacity)

This control status is only valid for controllers connected to the pCO via RS485. If there is a change in unit cooling capacity of at least 10%, sent from the pCO via RS485, the valve is positioned proportionally. In practice, this involves repositioning starting from the current position in proportion to how much the cooling capacity of the unit has increased or decreased in percentage terms. When the calculated position has been reached, regardless of the time taken, there is a constant 5 second delay before the actual control phase starts.

Note: if information is not available on the variation in unit cooling capacity, this will always be considered as operating at 100% and therefore the procedure will never be used. In this case, the PID control must be more reactive (see the chapter on Control) so as to react promptly to variations in load that are not communicated to the driver.

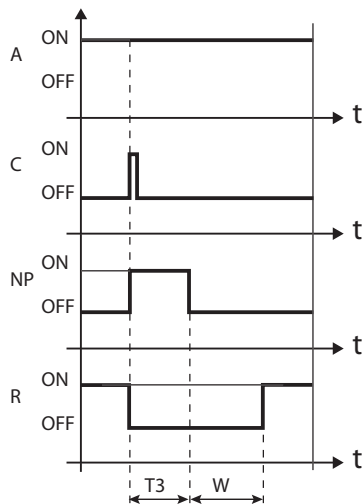

Fig. 8.p

Key:

A	Control request	R	Control
C	Change in capacity	T3	Repositioning time
NP	Repositioning	t	Time
W	Wait		

Stop/end control

The stop procedure involves closing the valve from the current position until reaching 0 steps, plus a further number of steps so as to guarantee complete closing. Following the stop phase, the valve returns to standby.

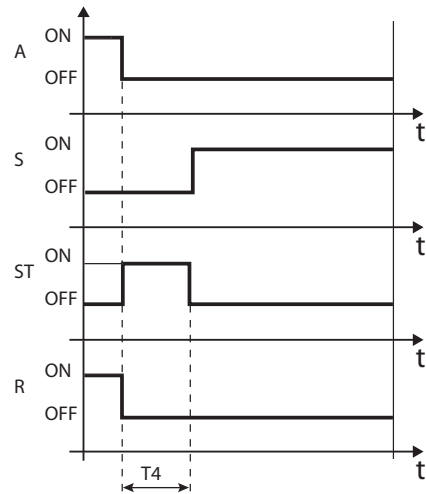

Fig. 8.q

Key:

A	Control request	R	Control
S	Standby	T4	Stop position time
ST	Stop	t	Time

8.10 Special control states

As well as normal control status, the driver can have three special states related to specific functions:

- manual positioning: this is used to interrupt control so as to move the valve, setting the desired position;
- recover physical valve position: recover physical valve steps when fully opened or closed;
- unblock valve: forced valve movement if the driver considers it to be blocked.

Manual positioning

Manual positioning can be activated at any time during the standby or control phase. Manual positioning, once enabled, is used to freely set the position of the valve using the corresponding parameter.

Control is placed on hold, all the system and control alarms are enabled, however neither control nor the protectors can be activated. Manual positioning thus has priority over any driver state/protector.

Par.	Description	Def.	Min.	Max.	UoM
U1	Enable manual valve positioning: 0/1=yes/no	0	0	1	-
U2	Manual valve position	0	0	999	step

Notes:

1. the manual positioning status is NOT saved when restarting after a power failure.
2. in for any reason the valve needs to be kept stationary after a power failure, proceed as follows:
 - remove the valve stator;
 - set the PID proportional gain =0. The valve will remain stopped at the initial opening position, set by corresponding parameter

Retrieve physical valve position

This procedure is necessary as the stepper motor intrinsically tends to lose steps during movement. Given that the control phase may last continuously for several hours, it is probable that from a certain time on the estimated position sent by the valve driver does not correspond exactly to the physical position of the movable element. This means that when the driver reaches the estimated fully closed or fully open position, the valve may physically not be in that position. The "Synchronisation" procedure allows the driver to perform a certain number of steps in the suitable direction to realign the valve.



Note: realignment is an intrinsic part of the forced closing procedure and is activated whenever the driver is stopped/started and in the standby phase.

Unblock valve

This procedure is only valid when the driver is performing superheat control. Unblock valve is an automatic safety procedure that attempts to unblock a valve that is supposedly blocked based on the control variables (superheat, valve position). The unblock procedure may or may not succeed depending on the extent of the mechanical problem with the valve. If for 10 minutes the conditions are such as to assume the valve is blocked, the procedure is run a maximum of 5 times. The symptoms of a blocked valve do not necessarily mean a mechanical blockage. They may also represent other situations:

- mechanical blockage of the solenoid valve upstream of the electronic valve (if installed);
- electrical damage to the solenoid valve upstream of the electronic valve;
- blockage of the filter upstream of the electronic valve (if installed);
- electrical problems with the electronic valve motor;
- electrical problems in the driver-valve connection cables;
- incorrect driver-valve electrical connection;
- electronic problems with the valve control driver;
- secondary fluid evaporator fan/pump malfunction;
- insufficient refrigerant in the refrigerant circuit;
- refrigerant leaks;
- lack of subcooling in the condenser;
- electrical/mechanical problems with the compressor;
- processing residues or moisture in the refrigerant circuit.



Note: the valve unblock procedure is nonetheless performed in each of these cases, given that it does not cause mechanical or control problems. Therefore, also check these possible causes before replacing the valve.

9. ALARMS

9.1 Types of alarms

There are two types of alarms:

- system: EEPROM, probe and communication;
- control: low superheat, LOP, MOP, low suction temperature.

The activation of the alarms depends on the setting of the threshold and activation delay parameters. The EEPROM unit parameters and operating parameters alarm always shuts down the controller and cannot be reset. All the alarms are reset automatically, once the causes are no longer present, except for the "Emergency closing not completed" alarm, which requires manual reset.

9.2 Probe alarms

The probe alarms are part of the system alarms. When the value measured by one of the probes is outside of the range of measurement, an alarm is activated. The alarm limits correspond to the range of measurement.

In the event of a probe alarm, the driver closes the valve, regardless of digital input status, until the error is no longer present.

Example: the display shows probe alarms A1 and A2 in sequence. The superheat value has exceeded the maximum limit allowed, and this is indicated by the two top segments.

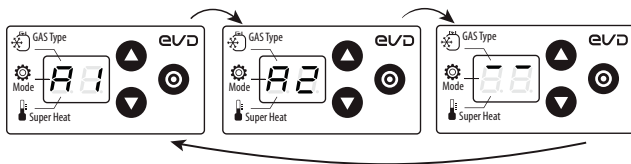

Fig. 9.a

Minimum and maximum superheat limits

If a probe alarm occurs, it may be due to the superheat value exceeding the allowed display range -5...55 K (-9 to 99°F). The display therefore shows the probe alarm code (A1/A2) and:

1. if the superheat value is less than -5K, the display shows the two bottom segments;
2. if the superheat value is higher than 55K, the display shows the two top segments.

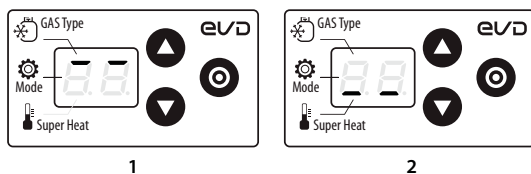

Fig. 9.b

9.3 Control alarms

These are alarms that are only activated during control.

Protector alarms

The alarms corresponding to the LowSH, LOP and MOP protectors are only activated during control when the corresponding activation threshold is exceeded, and only when the delay time defined by the corresponding parameter has elapsed. If a protector is not enabled (integral time= 0 s), no alarm will be signalled. If before the expiry of the delay, the protector control variable returns back inside the corresponding threshold, no alarm will be signalled.

Note: this is a likely event, as during the delay, the protection function will have an effect.

Low suction temperature alarm

The low suction temperature alarm is not linked to any protection function. It features a threshold and a fixed delay (300 seconds), and is useful in the event of probe or valve malfunctions to protect the compressor using the relay to control the solenoid valve or to simply signal a possible risk. In fact, incorrect measurement of the evaporation pressure or incorrect configuration of the type of refrigerant may mean the superheat calculated is much higher than the actual value, causing an incorrect and excessive opening of the valve. A low suction temperature measurement may in this case indicate probable flooding of the compressor, with corresponding alarm signal. The alarm is reset automatically, with a fixed differential of 3°C above the activation threshold.

Par.	Description	Def.	Min.	Max.	UoM
C8	Low suction temperature alarm threshold	-50 (-58)	-85 (-121)	200 (392)	°C(°F)

9.4 Valve emergency closing procedure

The following description only applies if EVD ice is connected to the Ultracap module.

In the event of a power failure, EVD ice can provide emergency closing of the valve, thus preventing any refrigerant from flowing to the compressor.

In this situation, the driver generates two alarms: E8 and E5. If the procedure concludes successfully (the valve closes completely), alarm E8 is cleared, however alarm E5 continues until the Ultracap module is able to power on the driver.

- E8: failed emergency closing (incomplete closing alarm). Active during the emergency closing stage and until the valve closes completely, after which alarm E8 is cleared. If the closing procedure is not completed (e.g. because the Ultracap module does not have enough charge), when next restarting the controller, the user must manually reset the alarm (pressing the PRG/SET button or setting the corresponding parameter to zero via serial connection);
- E5: emergency closing (emergency force closing alarm). This depends on a controller power failure and indicates that the emergency procedure is in progress.

Notes:

- if the voltage measured falls below a certain threshold, the controller, connected to the Ultracap module, can start the valve emergency closing procedure;
- during the valve emergency closing procedure, the display is switched off to save energy (therefore the alarms may not be shown on the display, or only shown for a brief instant);
- if power returns during the closing procedure, alarms E8 and E5 are reset and closing is completed in any case.

9.5 Network alarm

The digital input configuration parameter can only be set to control backup from the supervisor. If there is a communication error between the pCO controller and driver, the digital input status determines whether to continue control (input closed = the valve remains in the current position) or stop (input open).

9.6 Alarm table

Alarm code on the display	Red LED	Cause of the alarm	Reset	Effects on control	Checks / Solutions
A1	flashes	Probe S1 faulty or set alarm range exceeded	automatic	Valve closed	Check the probe connections.
A2	flashes	Probe S2 faulty or set alarm range exceeded	automatic	Valve closed	Check the probe connections.
E1	flashes	MOP protection activated	automatic	Protection action already in progress	Check parameter "MOP protection: threshold"
E2	flashes	LOP protection activated	automatic	Protection action already in progress	Check parameter "LOP protection: threshold"
E3	flashes	LowSH protection activated	automatic	Protection action already in progress	Check parameter "LowSH protection: threshold"
E4	flashes	Low suction temperature	automatic	No effect	Check the threshold parameter.
E5	flashes	Emergency closing	automatic	Valve closed	
E6	flashes	Network error	automatic	Control based on DI	Check the wiring and that the pCO is on and operating
E7	flashes	Ultracap module powered at low voltage or low charge	automatic	No effect	Check the wiring, the power supply and that the minimum recharge time has elapsed
E8	flashes	Emergency closing not completed	Manual	Valve closed	Press PRG/Set or set the corresponding supervisor variable to 0
EE	on steady	EEPROM operating and/or unit parameters damaged	Replace the driver/ Contact service	Total shutdown	Replace the driver/Contact service

Tab. 9.d

10. TROUBLESHOOTING

The following table lists a series of possible malfunctions that may occur when starting and operating the driver and the electronic valve. These cover the most common problems and are provided with the aim of offering an initial response for resolving the problem.

PROBLEM	CAUSE	SOLUTION
The superheat value measured is incorrect	The probe does not measure correct values	Check that the pressure and the temperature measured are correct and that the probe position is correct. Check the selection of pressure probe. Check the correct probe electrical connections.
	The type of refrigerant set is incorrect	Check and correct the type of refrigerant parameter.
Liquid returns to the compressor during control	The superheat set point is too low	Increase the superheat set point. Initially set it to 11 K and check that there is no longer return of liquid. Then gradually reduce the set point, always making sure there is no return of liquid.
	Low superheat protection ineffective	If the superheat remains low for too long with the valve that is slow to close, increase the low superheat threshold and/or decrease the low superheat integration time. Initially set the threshold 3 °C below the superheat set point, with an integration time of 3-4 seconds. Then gradually lower the low superheat threshold and increase the low superheat integration time, checking that there is no return of liquid in any operating conditions.
	Stator broken	Enable the manual positioning and check the opening and closure of the valve.
	Valve stuck open	Check if the superheating is always low (<2 °C) with the valve position permanently at 0 steps. If so, set the valve to manual control and close it completely. If the superheat is always low, check the electrical connections and/or replace the valve.
Liquid returns to the compressor only after defrosting (for multiplexed cabinets only)	The "valve opening at start-up" parameter is too high on many cabinets in which the control set point is often reached (for multiplexed cabinets only)	Decrease the value of the "Valve opening at start-up" parameter on all the utilities, making sure that there are no repercussions on the control temperature.
	The superheat temperature measured by the driver after defrosting and before reaching operating conditions is very low for a few minutes	Check that the LowSH threshold is greater than the superheat value measured and that the corresponding protection is activated (integration time >0 s). If necessary, decrease the value of the integration time.
	The superheat temperature measured by the driver does not reach low values, but there is still return of liquid to the compressor rack	Set more reactive parameters to bring forward the closing of the valve: increase the proportional factor to 30, increase the integration time to 250 s.
	Many cabinets defrosting at the same time	Stagger the start defrost times. If this is not possible, if the conditions in the previous two points are not present, increase the superheat set point and the LowSH thresholds by at least 2 °C on the cabinets involved.
Liquid returns to the compressor only when starting the controller (after being OFF)	The valve is significantly oversized	Replace the valve with a smaller equivalent.
	The "valve opening at start-up" parameter is set too high	Check the calculation in reference to the ratio between the rated cooling capacity of the evaporator and the capacity of the valve; if necessary, lower the value.
The superheat value swings around the set point with an amplitude greater than 4°C	The condensing pressure swings	Check the controller condenser settings, giving the parameters "blander" values (e.g. increase the proportional band or increase the integration time). Note: the required stability involves a variation within +/- 0.5 bars. If this is not effective or the settings cannot be changed, adopt electronic valve control parameters for perturbed systems
	The superheat swings even with the valve set in manual control (in the position corresponding to the average of the working values)	Check for the causes of the swings (e.g. low refrigerant charge) and resolve where possible.
	The superheat does NOT swing with the valve set in manual control (in the position corresponding to the average of the working values)	As a first approach, decrease (by 30 to 50 %) the proportional factor. Subsequently try increasing the integration time by the same percentage. In any case, adopt parameter settings recommended for stable systems.
	The superheat set point is too low	Increase the superheat set point and check that the swings are reduced or disappear. Initially set 13 °C, then gradually reduce the set point, making sure the system does not start swinging again and that the unit temperature reaches the control set point.
In the start-up phase with high evaporator temperatures, the evaporation pressure is high	MOP protection disabled or ineffective	Activate the MOP protection by setting the threshold to the required saturated evaporation temperature (high evaporation temperature limit for the compressors) and setting the MOP integration time to a value above 0 (recommended 4 seconds). To make the protection more reactive, decrease the MOP integration time.
	Refrigerant charge excessive for the system or extreme transitory conditions at start-up (for cabinets only).	Apply a "soft start" technique, activating the utilities one at a time or in small groups. If this is not possible, decrease the values of the MOP thresholds on all the utilities.

PROBLEM	CAUSE	SOLUTION
In the start-up phase the low pressure protection is activated (only for self-contained units)	The "Valve opening at start-up" parameter is set too low	Check the calculation in reference to the ratio between the rated cooling capacity of the evaporator and the capacity of the valve; if necessary increase the value.
	The driver in RS485 network does not start control and the valve remains closed	Check the serial connection. Check that the pCO application connected to the driver (where featured) correctly manages the driver start signal. Check that the driver is NOT in stand-alone mode.
	The driver in stand-alone configuration does not start control and the valve remains closed	Check the connection of the digital input. Check that when the control signal is sent that the input is closed correctly. Check that the driver is in stand-alone mode.
	LOP protection disabled	Set a LOP integration time greater than 0 s.
	LOP protection ineffective	Make sure that the LOP protection threshold is at the required saturated evaporation temperature (between the rated evaporation temperature of the unit and the corresponding temperature at the calibration of the low pressure switch) and decrease the value of the LOP integration time.
	Solenoid blocked	Check that the solenoid opens correctly, check the electrical connections.
	Insufficient refrigerant	Check that there are no bubbles in the sight glass upstream of the expansion valve. Check that the subcooling is suitable (greater than 5 °C); otherwise charge the circuit.
	The valve is connected incorrectly (rotates in reverse) and is open	Check the movement of the valve by placing it in manual control and closing or opening it completely. One complete opening must bring a decrease in the superheat and vice-versa. If the movement is reversed, check the electrical connections.
	Stator broken or connected incorrectly	Disconnect the stator from the valve and the cable and measure the resistance of the windings using an ordinary tester. The resistance of both should be around 36 ohms. Otherwise replace the stator. Finally, check the electrical connections of the cable to the driver (see paragraph 5.1).
The unit switches off due to low pressure during control (only for self-contained units)	Valve stuck closed	Use manual control after start-up to completely open the valve. If the superheat remains high, check the electrical connections and/or replace the valve.
	LOP protection disabled	Set a LOP integration time greater than 0 s.
	LOP protection ineffective	Make sure that the LOP protection threshold is at the required saturated evaporation temperature (between the rated evaporation temperature of the unit and the corresponding temperature at the calibration of the low pressure switch) and decrease the value of the LOP integration time.
	Solenoid blocked	Check that the solenoid opens correctly, check the electrical connections and the operation of the control relay.
	Insufficient refrigerant	Check that there are no bubbles of air in the liquid indicator upstream of the expansion valve. Check that the subcooling is suitable (greater than 5 °C); otherwise charge the circuit.
	The valve is significantly undersized	Replace the valve with a larger equivalent.
	Stator broken	Enable the manual positioning and check the opening and closure of the valve.
The cabinet does not reach the set temperature, despite the valve being opened to the maximum (for multiplexed cabinets only)	Valve stuck closed	Use manual control after start-up to completely open the valve. If the superheat remains high, replace the valve body.
	Solenoid blocked	Check that the solenoid opens correctly, check the electrical connections and the operation of the relay.
	Insufficient refrigerant	Check that there are no bubbles of air in the liquid indicator upstream of the expansion valve. Check that the subcooling is suitable (greater than 5 °C); otherwise charge the circuit.
	The valve is significantly undersized	Replace the valve with a larger equivalent.
	Stator broken	Enable the manual positioning and check the opening and closure of the valve.
The cabinet does not reach the set temperature, and the position of the valve is always 0 (for multiplexed cabinets only)	Valve stuck closed	Use manual control after start-up to completely open the valve. If the superheat remains high, replace the valve body.
	The driver in RS485 network does not start control and the valve remains closed	Check the network connections. Check that the pCO application connected to the driver (where featured) correctly manages the driver start signal. Check that the driver is NOT in stand-alone mode.
	The driver in stand-alone configuration does not start control and the valve remains closed	Check the connection of the digital input. Check that when the control signal is sent that the input is closed correctly. Check that the driver is in stand-alone mode.

Tab. 10.a

11. TECHNICAL SPECIFICATIONS

Power supply	115...230 Vac (+10/-15%) 50/60 Hz
Power input max (W)	15
Emergency power supply	13 Vdc +/-10% (If it is installed the optional Ultracap module for EVD ice, for EVDM011R1*/EVDM011R2*)
Driver	Unipolar valve
Valve connection	6-wire cable AWG 18/22 type, Lmax=1m
Digital input connection	digital input 230V optoisolated. Closing current: 10 mA Lmax=10m for residential/industrial environments, 2m for domestic environments
Probe	
	S1 ratiometric pressure probe (0...5 V): Resolution 0,1 % fs Measurement error: 2% fs max; 1% typical
	S2 low temperature NTC: 10kΩ a 25°C, -50T90°C Measurement error: 1°C in the range -50T50°C; 3°C in the range +50T90°C
RS485 serial connection	Modbus, Lmax=500m, shielded cable, earth connection in both side of shielded-cable
Assembly	with screw
Dimensions	LxHxW= 93 x 230 x 41 mm
Operating conditions	-30T40°C (don't use EVDIS* lower than -20°C); <90% U.R. non-condensing
Storage conditions	-35T60°C (don't store EVDIS* lower than -30°C), humidity 90% U.R. non-condensing
Index of protection	IP65/IP67
Environmental pollution	2
Temperature for glow wire test	850°C
Immunity against voltage surges	Category II
Class of insulation	II
Software class and structure	A
Conformity	Electrical safety: EN 60730-1, UL 60730-1, UL 60730-2-9 Electromagnetic compatibility: EN 61000-6-1, EN 61000-6-2, EN 61000-6-3, EN 61000-6-4 EN61000-3-2, EN55014-1, EN61000-3-3

Tab. 11.a

CAREL

CAREL INDUSTRIES HeadQuarters

Via dell'Industria, 11 - 35020 Brugine - Padova (Italy)

Tel. (+39) 049.9716611 - Fax (+39) 049.9716600

e-mail: carel@carel.com - www.carel.com

Agenzia / Agency: