

UNJ6220ZX

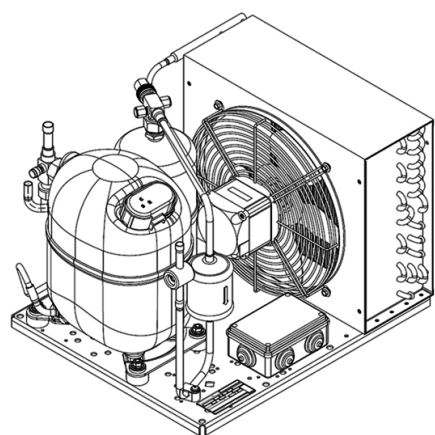

ENGINEERING CODE
548PM5603AA



POWER SUPPLY
380-420 V 50 Hz



MOTOR TYPE
3PH



REFRIGERANT
R-134a



APPLICATION
HBP



STANDARD
EN13215_RG20

CE

ECODESIGN COMPLIANT



COOLING CAPACITY
1260 W



EFFICIENCY
1.74 W/W

DATA

GENERAL DATA

Model UNJ6220ZX

ACCESSORIES

Discharge valve	SOLDER 3/8"	2110049
Suction valve	SOLDER 1/2"	2110050

CONDENSING COMPONENTS

Compressor	NJ6220ZX	M/HBP
Condenser	3R12T	2451140
Refrigerant	R-134a	
Expansion Device	C-V	
Fan Blade Diameter	275	
Fankit	34W/400V 275/31	1996582

MECHANICAL DATA

Air Flow	640 m ³ /h
Height	324 mm
Receiver	2.3 L
Shaft Power	34
Weight	35 Kg
Width	410 mm
Length	481 mm

PERFORMANCE

TESTED CONDITIONS

Tested Refrigerant	R-134a
Tested Application	HBP
Tested Standard	EN13215_RG20

RATED POINTS

Ambient Temperature °C	Evaporating Temperature °C	Cooling Capacity W	Efficiency W/W	Consumo de Potencia W
32	-10	1260	1.74	723

Test Condition: Subcooling 3 K, Return Gas 20 °C.

PERFORMANCE CURVE

Ambient Temperature 25°C

Evaporating Temperature °C	Cooling Capacity W	Efficiency W/W	Consumo de Potencia W
-15	1117	1.78	628
-5	1687	2.16	782
0	2021	2.33	868
5	2390	2.50	957
10	2792	2.66	1051

Test Condition: Subcooling 3 K, Return Gas 20 °C.

PERFORMANCE CURVE

Ambient Temperature 32°C

Evaporating Temperature °C	Cooling Capacity W	Efficiency W/W	Consumo de Potencia W
-15	1015	1.56	649
-5	1534	1.91	804
0	1839	2.06	891
5	2173	2.20	985
10	2538	2.34	1085

Test Condition: Subcooling 3 K, Return Gas 20 °C.

PERFORMANCE CURVE

Ambient Temperature 43°C

Evaporating Temperature °C	Cooling Capacity W	Efficiency W/W	Consumo de Potencia W
-15	838	1.30	647
-5	1306	1.58	825
0	1576	1.70	929
5	1870	1.79	1042

Test Condition: Subcooling 3 K, Return Gas 20 °C.

ENVELOPE

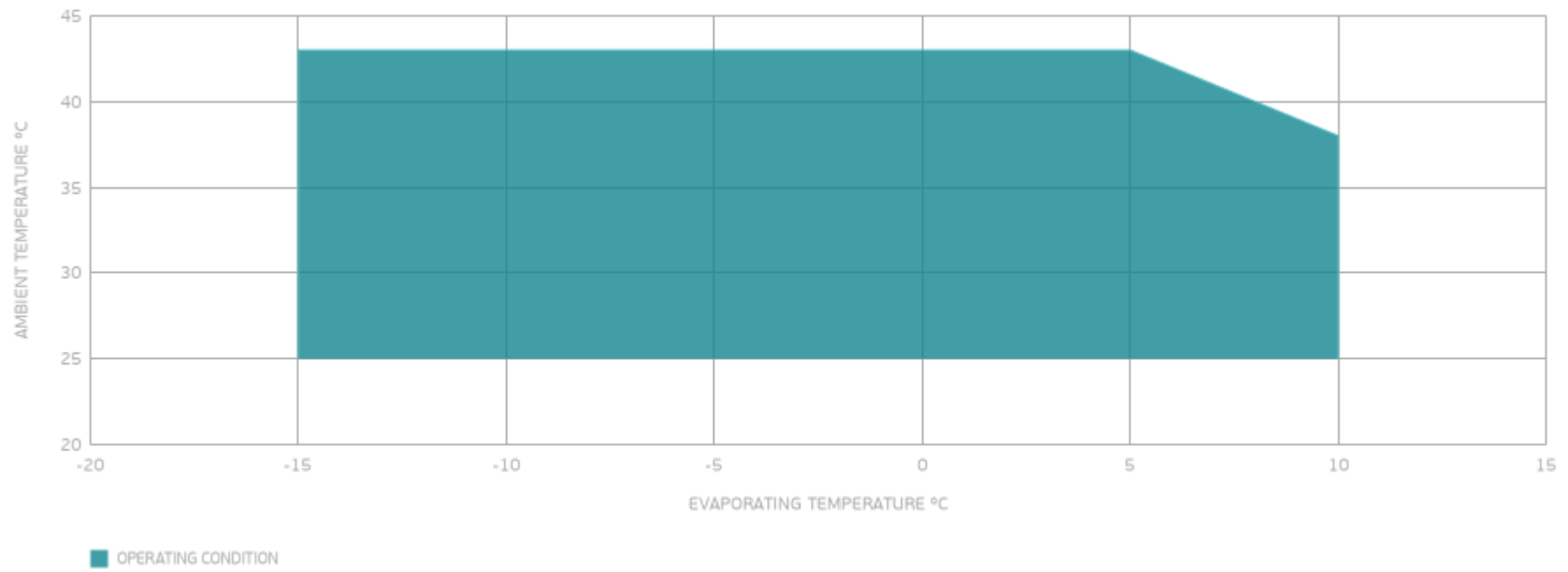

EXTERNAL DIMENSIONS

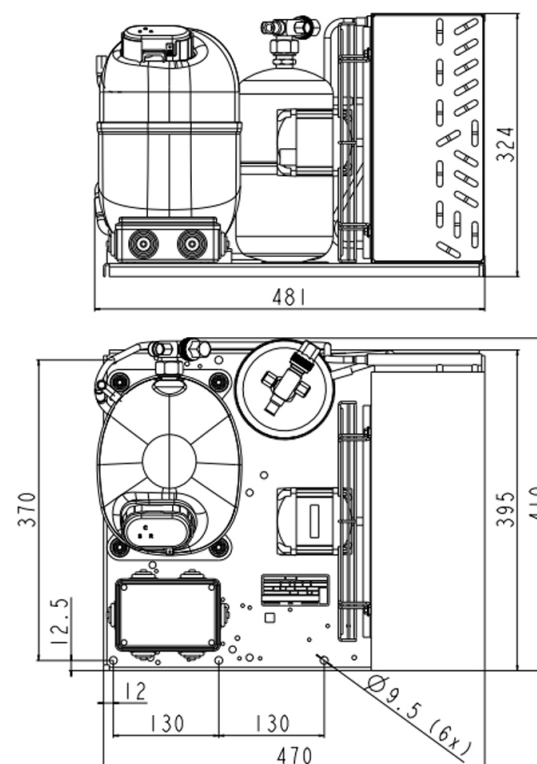

WIRING DIAGRAM

